



INSTALLATION MANUAL

Split System air conditioners

FDY125B7V1
FDY200B7V1
FDY250B7V1

FDYP125B7V1
FDYP200B7V1
FDYP250B7V1

FDQ125B7V3B

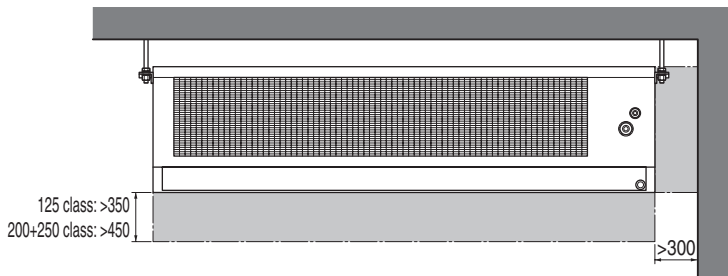

1

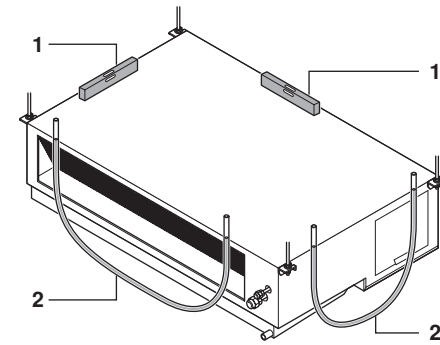
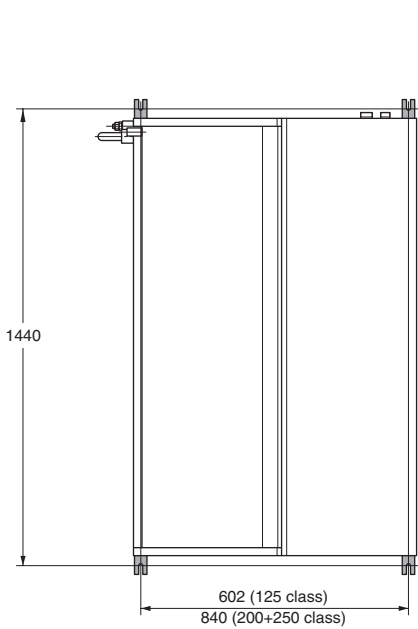

3

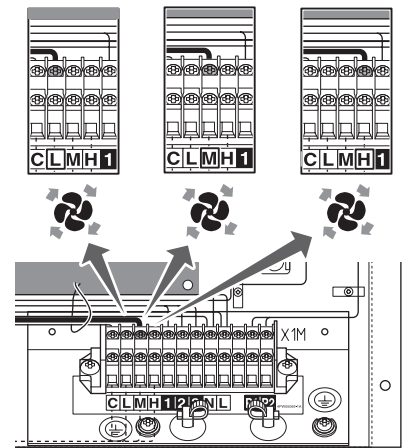
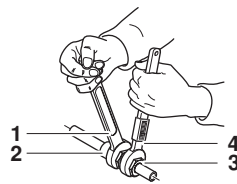

2

4

5

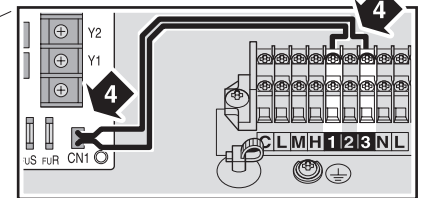
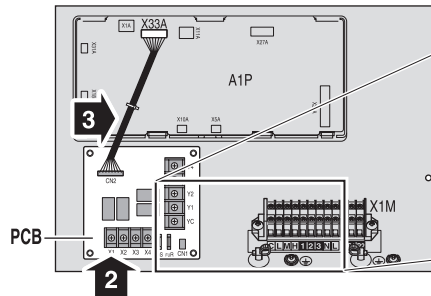
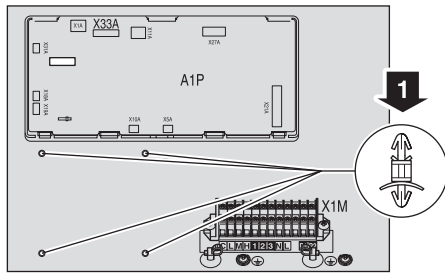

6

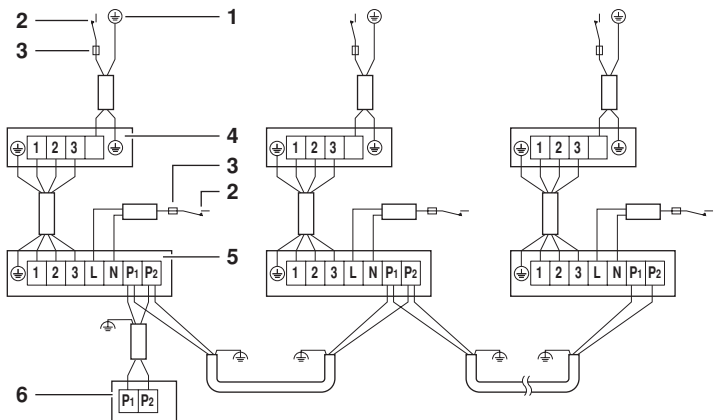
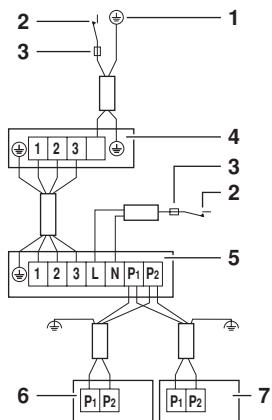
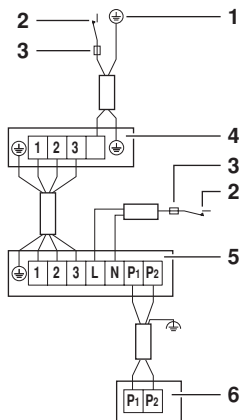

7

8

9

Daikin Europe N.V.

declares under its sole responsibility that the air conditioning models to which this declaration relates:
erklärt auf seine alleinige Verantwortung daß die Modelle der Klimageräte für die diese Erklärung bestimmt ist:
déclare sous sa seule responsabilité que les appareils d'air conditionné visés par la présente déclaration:

verklaart hierbij op eigen exclusieve verantwoordelijkheid dat de airconditioning units waarop deze verklaring betrekking heeft:
declara baja su única responsabilidad que los modelos de aire acondicionado a los cuales hace referencia la declaración:
dichiara sotto sua responsabilità che i condizionatori modello a cui è riferita questa dichiarazione:

δηλώνει με αποκλειστική της ευθύνη ότι τα μοντέλα των κλιματιστικών συσκευών στα οποία αναφέρεται η παρούσα δήλωση:
declara sob sua exclusiva responsabilidade que os modelos de ar condicionado a que esta declaração se refere:
erklærer under eneansvar, at klimateknologimodellerne, som denne deklaration vedrører:

deklarerar i egenskap av huvudansvarig, att luftkonditioneringsmodellerna som berörs av denna deklaration innebär att:
erklærer et fullstendig ansvar for at de luftkonditioneringsmodeller som berøres av denne deklarasjon innebærer at:
ilmoittaa yksinomaan omalla vastuullaan, että tämän ilmoituksen tarkoitamat ilmastointilaitteiden mallit:

FDY125B7V1, FDY200B7V1, FDY250B7V1,
FDYP125B7V1, FDYP200B7V1, FDYP250B7V1,
FDQ125B7V3B,

are in conformity with the following standard(s) or other normative document(s), provided that these are used in accordance with our instructions:
der/den folgenden Norm(en) oder einem anderen Normdokument oder -dokumenten entspricht/entsprechen, unter der Voraussetzung, daß sie gemäß unseren Anweisungen eingesetzt werden:
sont conformes à la/aux norme(s) ou autre(s) document(s) normatif(s), pour autant qu'ils soient utilisés conformément à nos instructions:

conform de volgende norm(en) of één of meer andere bindende documenten zijn, op voorwaarde dat ze worden gebruikt overeenkomstig onze instructies:
están en conformidad con la(s) siguiente(s) norma(s) u otro(s) documento(s) normativo(s), siempre que sean utilizados de acuerdo con nuestras instrucciones:
sono conformi al(i) seguente(i) standard(s) o altro(i) documento(i) a carattere normativo, a patto che vengano usati in conformità alle nostre istruzioni:

είναι σύμφωνα με το(α) ακόλουθο(α) πρότυπο(α) ή άλλο έγγραφο(α) κανονισμών, υπό την προϋπόθεση ότι χρησιμοποιούνται σύμφωνα με τις οδηγίες μας:
estão em conformidade com a(s) seguinte(s) norma(s) ou outro(s) documento(s) normativo(s), desde que estes sejam utilizados de acordo com as nossas instruções:
overholder følgende standard(er) eller andet/andre retningsgivende dokument(er), forudsat at disse anvendes i henhold til vore instruksjer:

respektive utrustning är utförd i överensstämmelse med och följer följande standard(er) eller andra normgivande dokument, under förutsättning att användning sker i överensstämmelse med våra instruktioner:
respektive utstyr er i overensstemmelse med følgende standard(er) eller andre normgivende dokument(er), under forutsetning av at disse brukes i henhold til våre instruksjer:
vastaavat seuraavien standardien ja muiden ohjeellisten dokumenttien vaatimuksia edellyttäen, että niitä käytetään ohjeidemme mukaisesti:

EN60335-2-40,

following the provisions of:
gemäß den Vorschriften der:
conformément aux stipulations des:
overeenkomstig de bepalingen van:
siguiendo las disposiciones de:
secondo le prescrizioni per:
με τήρηση των διατάξεων των:
de acordo com o previsto em:
under iagttagelse af bestemmelserne i:
enligt villkoren i:
gitt i henhold til bestemmelsene i:
noudattaen määräyksiä:

Low Voltage 73/23/EEC
Machinery Safety 98/37/EEC
Electromagnetic Compatibility 89/336/EEC*

Directives, as amended.
Direktiven, gemäß Änderung.
Directives, telles que modifiées.
Richtlijnen, zoals geamendeerd.
Directivas, según lo enmendado.
Direttive, come da modifica.
Οδηγιών, όπως έχουν τροποποιηθεί.
Directivas, conforme alteração em.
Direktiver, med senere ændringer.
Direktiv, med företagna ändringar.
Direktiver, med foretatte ændringer.
Direktivejä, sellaisina kuin ne ovat muutettuina.

* Note	as set out in the Technical Construction File DAIKIN.TCF.004, .016, .021 and judged positively by KEMA according to the Certificate 59277-KRQ/ECM95-4233/81728-KRQ/EMC98-4341/2024351-QUA/EMC02-4565.
Hinweis	wie in der Technischen Konstruktionsakte DAIKIN.TCF.004, .016, .021 aufgeführt und von KEMA positiv ausgezeichnet gemäß Zertifikat 59277-KRQ/ECM95-4233/81728-KRQ/EMC98-4341/2024351-QUA/EMC02-4565.
Remarque	tel que stipulé dans le Fichier de Construction Technique DAIKIN.TCF.004, .016, .021 et jugé positivement par KEMA conformément au Certificat 59277-KRQ/ECM95-4233/81728-KRQ/EMC98-4341/2024351-QUA/EMC02-4565.
Bemerk	zoals vermeld in het Technisch Constructiedossier DAIKIN.TCF.004, .016, .021 en in orde bevonden door KEMA overeenkomstig Certificaat 59277-KRQ/ECM95-4233/81728-KRQ/EMC98-4341/2024351-QUA/EMC02-4565.
Nota	tal como se expone en el Archivo de Construcción Técnica DAIKIN.TCF.004, .016, .021 y juzgado positivamente por KEMA según el Certificado 59277-KRQ/ECM95-4233/81728-KRQ/EMC98-4341/2024351-QUA/EMC02-4565.
Nota	delineato nel File Tecnico di Costruzione DAIKIN.TCF.004, .016, .021 e giudicato positivamente da KEMA secondo il Certificato 59277-KRQ/ECM95-4233/81728-KRQ/EMC98-4341/2024351-QUA/EMC02-4565.
Σημείωση	όπως προορίζεται στο Αρχείο Τεχνικής Κατασκευής DAIKIN.TCF.004, .016, .021 και κρίνεται θετικά από το KEMA σύμφωνα με το Πιστοποιητικό 59277-KRQ/ECM95-4233/81728-KRQ/EMC98-4341/2024351-QUA/EMC02-4565.
Nota	tal como estabelecido no Ficheiro Técnico de Construção DAIKIN.TCF.004, .016, .021 e com o parecer positivo de KEMA de acordo com o Certificado 59277-KRQ/ECM95-4233/81728-KRQ/EMC98-4341/2024351-QUA/EMC02-4565.
Bemærk	som anført i den Tekniske Konstruktionsfil DAIKIN.TCF.004, .016, .021 og positivt vurderet af KEMA i henhold til Certifikat 59277-KRQ/ECM95-4233/81728-KRQ/EMC98-4341/2024351-QUA/EMC02-4565.
Information	utrustningen är utförd i enlighet med den Tekniska Konstruktionsfilen DAIKIN.TCF.004, .016, .021 som positivt intygas av KEMA vilket också framgår av Certifikat 59277-KRQ/ECM95-4233/81728-KRQ/EMC98-4341/2024351-QUA/EMC02-4565.
Merk	som det fremkommer i den Tekniske Konstruktionsfilen DAIKIN.TCF.004, .016, .021 og gennem positiv bedømmelse af KEMA ifølge Certifikat 59277-KRQ/ECM95-4233/81728-KRQ/EMC98-4341/2024351-QUA/EMC02-4565.
Huom	jotka on esitetty Teknisessä Asiakirjassa DAIKIN.TCF.004, .016, .021 ja jotka KEMA on hyväksynyt Sertifiikaatin 59277-KRQ/ECM95-4233/81728-KRQ/EMC98-4341/2024351-QUA/EMC02-4565 mukaisesti.



DAIKIN EUROPE NV
Zandvoordestraat 300, B-8400 Oostende, Belgium

CONTENTS

	Page
Before installation.....	1
Selecting installation site.....	1
Check list.....	1
Preparations before installation.....	2
Indoor unit installation.....	2
Refrigerant piping work.....	2
Vacuum drying of installation.....	3
Drain piping work.....	3
Drain check.....	3
Field wiring.....	3
Field setting.....	4
Test operation.....	4
Internal wiring - parts table.....	5



READ THESE INSTRUCTIONS CAREFULLY BEFORE INSTALLATION.

KEEP THIS MANUAL IN A HANDY PLACE FOR FUTURE REFERENCE.

IMPROPER INSTALLATION OR ATTACHMENT OF EQUIPMENT OR ACCESSORIES COULD RESULT IN ELECTRIC SHOCK, SHORT-CIRCUIT, LEAKS, FIRE OR OTHER DAMAGE TO THE EQUIPMENT. BE SURE ONLY TO USE ACCESSORIES MADE BY DAIKIN WHICH ARE SPECIFICALLY DESIGNED FOR USE WITH THE EQUIPMENT AND HAVE THEM INSTALLED BY A PROFESSIONAL.

IF UNSURE OF INSTALLATION PROCEDURES OR USE, ALWAYS CONTACT YOUR DAIKIN DEALER FOR ADVICE AND INFORMATION.

BEFORE INSTALLATION

- Decide upon a line of transport.
- Leave the unit inside its packaging while moving, until reaching the installation site. Where unpacking is unavoidable, use a sling of soft material or protective plates together with a rope when lifting, to avoid damage or scratches to the unit.
- Caution concerning refrigerant series R-410A:
 - The connectable outdoor units must be designed exclusively for R-410A.
 - If outdoor units for R22, R-407C are connected, the system will not work properly.

Accessories

Check if the following accessories are included with your unit.



Installation manual, Operation manual

Note to the installer

Be sure to instruct the customer how to properly operate the system and show him/her the attached operation manual.

SELECTING INSTALLATION SITE

1. Select an installation site where the following conditions are fulfilled and that meets your customer's approval.
 - Where the ceiling is strong enough to support the weight of the unit and to prevent vibration and noise generation.
 - Where sufficient clearance for maintenance and service can be ensured (Refer to figure 1: ■ = service space). The power supply intake (1), drain connection (2), gas pipe (3) and liquid pipe (4) connection should always be accessible for maintenance and service.
 - Where piping between indoor and outdoor units is possible within the allowable limit. (Refer to the installation manual for the outdoor unit.)
 - There is no danger of fire due to leakage of flammable gas.
 - Ensure that water can not cause any damage to the location in case it drips out of the unit (e.g. in case of a blocked drain pipe).
 - Please consult with your dealer for installing in a special environment (e.g. a place in oily surroundings, a place with sulfide gas, a place where chemicals are used nearby, a place with high voltage fluctuations, a place with volatile flammable gas, a place in which machinery generates electromagnetic waves).
2. Use suspension bolts for installation. Check whether the ceiling is strong enough to support the weight of the unit or not. If there is a risk, reinforce the ceiling before installing the unit.

CHECK LIST

For the following items, take special care during construction and check after installation is finished

Tick ✓ when checked	
<input type="checkbox"/>	Is the indoor unit securely installed?
<input type="checkbox"/>	Is the gas leakage checked?
<input type="checkbox"/>	Is the heat insulation: <ul style="list-style-type: none"> <input type="checkbox"/> For the gas pipe adequate? <input type="checkbox"/> For the liquid pipe adequate? <input type="checkbox"/> For the indoor side extension drain hose adequate?
<input type="checkbox"/>	Does the drain flow out smoothly?
<input type="checkbox"/>	Are the line voltages within tolerance?
<input type="checkbox"/>	Is the earth wire earthed?
<input type="checkbox"/>	Are wiring and piping correct?
<input type="checkbox"/>	Are the air inlet and outlet of the indoor and outdoor unit not blocked?
<input type="checkbox"/>	Are refrigerant piping length and additional refrigerant charge noted down?

PREPARATIONS BEFORE INSTALLATION

- Suspension bolt position (Refer to [figure 2](#)).
- The fan speed for this indoor unit is preset to provide standard external static pressure.
 - If higher or lower external static pressure is required, reset the external static pressure by changing the initial setting on the terminal in the indoor switchbox. Refer to the section entitled "Field setting" on [page 4](#).

NOTE



When connecting the air conditioning unit to the ducting, a pressure drop will be created and the evaporator airflow will be reduced. The maximum external static pressure may not exceed the following values:

	Max. ESP
FDY(P)125	150 Pa
FDY(P)200	250 Pa
FDY(P)250	250 Pa
FDQ125	150 Pa

- Install the suspension bolts (Refer to "Installation example" on [page 2](#)).
Use M10 size bolt for the suspension bolt. Use anchors for existing ceilings, and a sunken insert, sunken anchor or other field supplied parts for new ceilings to reinforce the ceiling to bear the weight of the unit.

Installation example

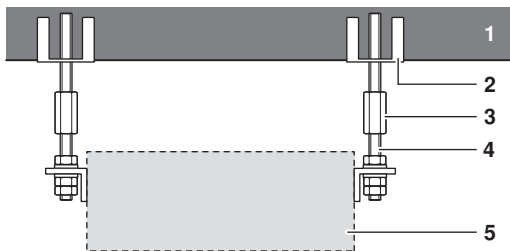

- Ceiling slab
- Anchor
- Long nut or turn-buckle
- Suspension bolt
- Indoor unit

Note: Mentioned parts are field supplied

INDOOR UNIT INSTALLATION

When installing optional accessories, refer to the instruction manual of each optional accessory. Depending on the field conditions, it may be easier to install optional accessories before the indoor unit is installed.

- Install the indoor unit temporarily.
 - Attach the hanger bracket to the suspension bolt. Be sure to fix it securely by using a nut and washer from the upper and lower sides of the hanger bracket.

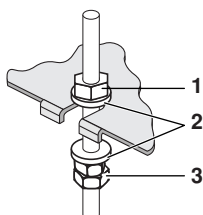

- Field procurement.
- Washer for hanger bracket
- Tighten (double nut)

- Do not install the unit tilted.
(If the unit is tilted against condensate flow, water can drip out of the drain pan).
Check if the unit is levelled at all four corners with a water level (1) or a water-filled vinyl tube (2) (Refer to [figure 3](#)).
- Tighten the upper nut.
- An air filter is installed to prevent dust accumulation on the heat exchanger. This will prolong the lifetime of the unit.
- Connect the air inlet to the air inlet ducting and the air outlet to the air outlet ducting. Always provide a flexible connection between the ducting flanges of the air conditioner and the ducts to prevent vibrations and noise generation.



Ensure that a protective guard is installed in front of the air outlet to prevent that the fan blades can be touched. The protection must comply with relevant local and national regulations.

REFRIGERANT PIPING WORK



All field piping must be installed by a licensed refrigeration technician and must comply with relevant local and national regulations.

For refrigerant piping of outdoor unit, see the installation manual attached to the outdoor unit.



A liquid line and gas line must be provided between the condensing and the air conditioning unit.

- The outdoor unit is charged with refrigerant.
- Use a pipe cutter and flare suitable for the used refrigerant.
- The liquid line must be connected to the air conditioning unit via a flare connection. The gas line must be welded directly to the air conditioning unit piping. In case of a FDY125 unit, both the liquid line and the gas line must be connected to the air conditioning via a flare connection.
- In case of flare connections, flare the pipe end neatly to avoid refrigerants leaks.
- Be sure to use both a spanner and torque wrench together when connecting or disconnecting pipes to/from the unit (Refer to [figure 4](#)).
- Refer to the table below for the dimensions of flare nut spaces.

Pipe gauge	Tightening torque	Flare dimension A (mm)		Flare shape
		R22, R-407C	R-410A	
Ø6.4	14.2~17.2 N•m (144~176 kgf•cm)	8.3~8.7	8.7~9.1	
Ø9.5	32.7~39.9 N•m (333~407 kgf•cm)	12.0~12.4	12.8~13.2	
Ø12.7	49.5~60.3 N•m (504~616 kgf•cm)	15.4~15.8	16.2~16.6	
Ø15.9	61.8~75.4 N•m (630~770 kgf•cm)	18.6~19.0	19.3~19.7	
Ø19.1	97.2~118.6 N•m (990~1210 kgf•cm)	22.9~23.3	—	

- Because R-407C/R-410A refrigerant is used, apply ether or ester oil around the flare portions before connecting.

Coat here with ether oil or ester oil

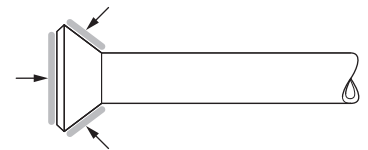

- Refer to the table above to determine the proper tightening torque. (Overtightening may damage the flare and cause leaks.)
- Check the pipe connector for gas leaks.
- Only wrap the gas line side of the insulation for fitting (union) with the sealing pad (attached).

VACUUM DRYING OF INSTALLATION

Refer to the installation manual of the outdoor unit.

DRAIN PIPING WORK

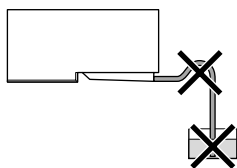

- The drain hose must slope downward to the outdoor side.
- Never put the end of the drain into water.

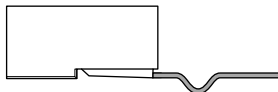

- A trap to prevent bad odours is allowed.
- If you extend the drain hose always insulate it up to the outdoor side with polyethylene foam insulation material (field supplied).

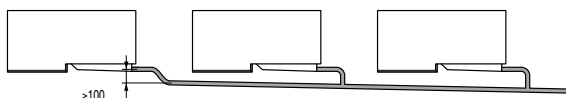

- To ensure a downward slope of minimum 1:100, install hanging bars every 1 to 1.5 m.
- If unifying multiple drain pipes, install pipes shown in the figure above.

DRAIN CHECK

Make sure that the drain hose is firmly connected. Put some water into the drain pan to check if the water flows smoothly.

FIELD WIRING



All field wiring and components must be installed by a licensed electrician and must comply with relevant local and national regulations.

The field wiring must be carried out in accordance with the wiring diagrams and the instructions given below.

Be sure to use a dedicated power circuit.

Never use a power supply shared by another appliance.

- Use copper wire only.
- For electric wiring work, refer also to "Internal wiring - parts table" on page 5.
- A circuit breaker capable of shutting down power supply to the entire system must be installed.
- Refer to the installation manual attached to the outdoor unit for the size of power supply electric wire connected to the outdoor unit, the capacity of the circuit breaker and switch, and wiring instructions.
- Refer to table below for specifications of field wire.

		Size (mm ²)	Length
Interconnection wire	H05VV-U4G (Note)	1	—
Unit remote controller	Sheathed wire (2 wires)	0.75-1.25	Max. 500 m
Power supply indoor fan	Must comply with relevant local and national regulations		



The table above presents the specifications of field wiring to be applied in case of protected pipes are used. Use HO5RN-F in case of no protection.

Methods of wiring units and connecting remote controller cords (Refer to figure 6)

- Wiring the units (Power supply wiring).
- Connect the interconnection wiring (from outdoor to indoor) to the 1-2-3 terminal (1) using a separate power supply wire to connect to power supply of the indoor unit fan motor to the L-N terminal.
- Remote controller code.
Connect the cords to the remote controller terminal (P1, P2) (No Polarity) (2).

Precautions

- Do not clamp remote controller cords together with the other wiring. Doing so may cause malfunction.
- Remote controller cords and wires connecting the units should be located at least 50 mm from other electric wires. Not following this guideline may result in malfunction due to electrical noise.

Observe the notes mentioned below when wiring to the power supply terminal board.

- Do not connect wires of different gauge to the same power supply terminal. (Looseness in the connection may cause overheating.)
- When connecting wires of the same gauge, connect them according to the figure below.

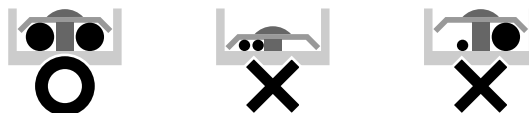

Wiring example

Pair type (Refer to figure 7)

Remote controller controls 1 indoor unit (standard system).

Control by two remote controllers (Refer to figure 8)

- 1 Main power supply
- 2 Main switch
- 3 Fuse
- 4 Outdoor unit
- 5 Indoor unit
- 6 Remote controller
- 7 Remote controller (Optional accessories)

Two remote controllers control 1 indoor unit.

Group control (Refer to figure 9)

Remote controller controls up to 16 indoor units.

(All indoor units operate according to the remote controller.)

NOTE



1. All transmission wiring except for the remote controller wires must match the terminal symbol.
2. Use shield wire in transmission wiring. Ground the shield of the shield wire to "⚡", at the grounding screw of the remote controller cord grounding terminal inside the control box.
3. For group control remote controller, choose the remote controller that suits the indoor unit which has the most functions (as attached swing flap).

Setting external static pressure

Depending on the external static pressure (ducts, filter, etc.) which is connected to the air conditioning unit the fan speed should be set by changing the wires in the switch box. (Refer to [figure 5](#))

Factory set: fan speed is **M**.

High ESP: fan speed is **H**.

Low ESP: fan speed is **L**.

Setting air filter sign

- Remote controllers are equipped with liquid crystal display air filter signs to display the time to clean air filters.
- Change the SECOND CODE No. according to the table depending on the amount of dirt or dust in the room. (SECOND CODE No. is factory set to "01" for filter contamination-light.)

Setting	Spacing time of display air filter sign (long life type)	Mode No.	FIRST CODE No.	SECOND CODE No.
Air filter contamination-light	±2500 hrs	10 (20)	0	01
Air filter contamination-heavy	±1250 hrs			02

Setting the remote sensor

The customer has the ability to select the thermistor. Both unit and remote controller are equipped with a thermistor.

Setting

Setting	Mode n°	1st code n°	2nd code n°
Enabled	20	2	01
Disabled	20	2	02

Change the second code n° according to the table to enable or disable the remote sensor.

TEST OPERATION

Refer to "[Check list](#)" on page 1.

After finishing the construction of refrigerant piping, drain piping, and electric wiring, conduct test operation accordingly to protect the unit.

1. Open the gas side stop valve.
2. Open the liquid side stop valve.
3. Electrify crank case heater for 6 hours.
4. Set to cooling operation with the remote controller and start operation by pushing ON/OFF button.
5. Press Inspection/Test Operation button 4 times and operate at Test Operation mode for 3 minutes.
6. Press Inspection/Test Operation button and operate normally.
7. Confirm function of unit according to the operation manual.

Precautions

In case something is wrong with the unit and it does not operate, refer to the malfunction diagnosis label attached to the unit.

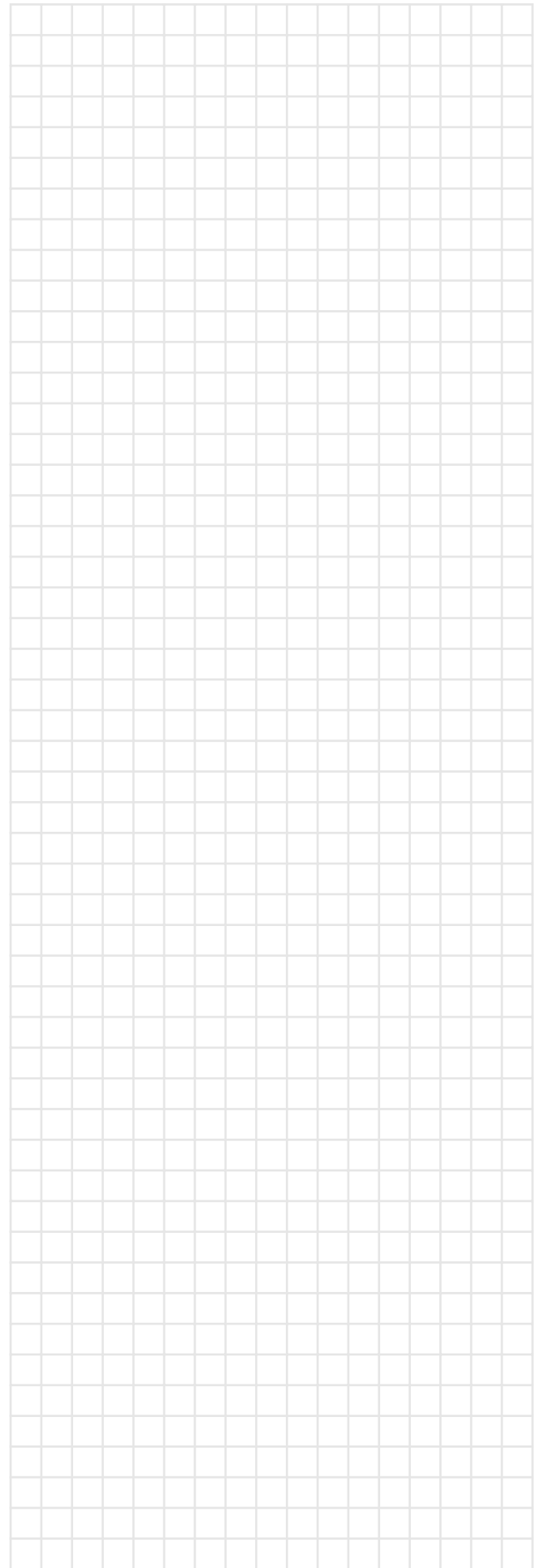

INTERNAL WIRING - PARTS TABLE

Refer to the wiring diagram on the unit.

The abbreviations used are listed below.

NOTE



When using the central remote controller, see manual for connection to the unit.

Ground the shield of the remote controller cord to the indoor unit.

Be sure that power supply is switched off before opening switch box.

	: FIELD WIRING
	: TERMINAL
	: CONNECTOR
	: PROTECTIVE EARTH (SCREW)
BLK	: BLACK
BLU	: BLUE
RED	: RED
WHT	: WHITE
YLW	: YELLOW

A1PPrinted circuit board
A2P Printed circuit board (Transformer 220-240 V/16 V) (only for FDY125, 200, 250)
A3PPrinted circuit board
C1RCapacitor (Fan)
F1TThermal fuse (M1F embedded)
HAP, HBPLight emitting diode (Service monitor - GREEN)
K1FMagnetic contactor (M1F)
M1FMotor (Fan)
R1TThermistor (air)
R2TThermistor (Coil)
RCSignal receiver circuit
RyF1Magnetic relay (fan)
SS1Selector switch (Emergency)
T1RTransformer
TCSignal transmission circuit
X1MTerminal strip

Adaptor for wiring

RyC, RyFMagnetic relay
----------	---------------------

Connector for optional parts

X25A Connector (Group control adaptor)
X30A Connector (interface adaptor for Sky Air series) (only for FDY(P)125~250)
X33A Connector (Adaptor for wiring)
X40A Connector (remote on/off, forced off)
X60A,X61A Connector (interface adaptor for Sky Air series) (only for FDQ)

Wired remote controller

BS2 Timer mode start/stop button
BS7 Timer on/off button
BS3-BS8 Programming timer button
BS1 ON/OFF button
BS4 Temperature setting button up
BS6 Operation mode selector button
BS9 Temperature setting button down
BS12 INSPECTION/TEST operation button
BS14 Filter sign reset button
LCD Liquid Crystal Display
H1P Light emitting diode (Service monitor-Red)
SS1 Selector switch (MAIN/SUB)

NOTES



