

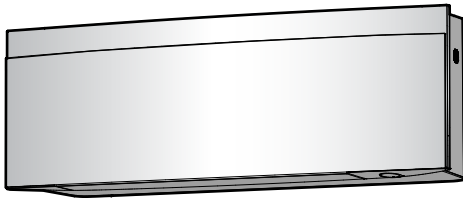

User reference guide

Daikin room air conditioner



Download the
ONECTA app

 **STAND BY ME**
Discover our service offer

FTXJ20A2V1BW9
FTXJ25A2V1BW9
FTXJ35A2V1BW9
FTXJ42A2V1BW9
FTXJ50A2V1BW9

FTXJ20A2V1BB9
FTXJ25A2V1BB9
FTXJ35A2V1BB9
FTXJ42A2V1BB9
FTXJ50A2V1BB9

FTXJ20A2V1BS9
FTXJ25A2V1BS9
FTXJ35A2V1BS9
FTXJ42A2V1BS9
FTXJ50A2V1BS9

Table of Contents

1	About the documentation	4
1.1	About this document.....	4
1.2	Meaning of warnings and symbols	5
2	User safety instructions	7
2.1	General	7
2.2	Instructions for safe operation	8
3	About the system	12
3.1	Indoor unit.....	12
3.1.1	Daikin eye indication lamp.....	13
3.2	About the user interface	14
3.2.1	Components: Wireless remote control.....	14
3.2.2	To operate the wireless remote control	15
3.2.3	Status: Wireless remote control LCD	15
3.2.4	Main menu: Wireless remote control	17
4	Before operation	20
4.1	To insert the batteries	20
4.2	To mount the wireless remote control magnetic holder	21
4.3	To turn on the power supply.....	21
4.4	Indoor unit setting.....	21
4.4.1	Brightness of the Daikin eye.....	22
4.4.2	Open the front panel	22
4.4.3	Wireless LAN connection	22
4.4.4	Vertical airflow function	27
4.4.5	About indoor unit installation position	27
4.4.6	Keep dry	28
4.5	Wireless remote control setting	28
4.5.1	To set contrast of the LCD	29
4.5.2	To set brightness of the LCD.....	29
4.5.3	To set automatic LCD turn off time	29
4.5.4	To set automatic send after select.....	29
4.5.5	To set a different channel of the indoor unit infrared signal receiver	30
5	Operation	31
5.1	Operation range	31
5.2	When to use which feature.....	31
5.3	Operation mode and temperature setpoint.....	33
5.3.1	To start/stop operation mode and to set the temperature	34
5.4	Airflow rate.....	34
5.4.1	To adjust the airflow rate	35
5.5	Airflow direction.....	35
5.5.1	To adjust vertical airflow direction.....	37
5.5.2	To adjust horizontal airflow direction	38
5.5.3	To use 3D airflow direction.....	38
5.5.4	To start/stop Comfort airflow operation	39
5.6	Intelligent eye operation.....	39
5.6.1	To start/stop Intelligent eye operation	39
5.7	Powerful operation	40
5.7.1	To start/stop Powerful operation.....	40
5.8	Econo operation	41
5.8.1	To start/stop Econo operation	41
5.9	Outdoor unit quiet operation	42
5.9.1	To start/stop Outdoor unit quiet operation.....	42
5.10	Flash Streamer (air cleaning) operation	43
5.10.1	To start/stop Flash Streamer (air cleaning) operation.....	43
5.11	Clock and timer setting	43
5.11.1	The clock setting	43
5.11.2	OFF/ON timer operation.....	45
5.11.3	Weekly timer operation.....	47
5.12	About Multi system	49
5.12.1	Priority room setting.....	49
5.12.2	Night quiet mode	50
5.12.3	Cooling/heating mode lock in Multi-system	50

6	Energy saving and optimum operation	51
7	Maintenance and service	53
7.1	Overview: Maintenance and service.....	53
7.2	To clean the indoor unit and wireless remote control.....	54
7.3	To clean the front panel.....	55
7.4	To open the front panel.....	55
7.5	About the air filters.....	56
7.6	To clean the air filters.....	56
7.7	To clean the titanium apatite deodorising filter and the silver particle filter (Ag-ion filter).....	57
7.8	To replace the titanium apatite deodorising filter and the silver particle filter (Ag-ion filter).....	58
7.9	To close the front panel.....	58
7.10	To remove the front panel.....	59
7.11	To take following items into account before a long idle period.....	59
8	Troubleshooting	61
8.1	Troubleshooting for wireless LAN connection.....	63
8.2	Solving problems based on error codes.....	64
8.3	Symptoms that are NOT system malfunctions.....	65
8.3.1	Symptom: A sound like water flowing is heard.....	65
8.3.2	Symptom: A blowing sound is heard.....	65
8.3.3	Symptom: A ticking sound is heard.....	65
8.3.4	Symptom: A whistling sound is heard.....	65
8.3.5	Symptom: A clicking sound during operation or idle time is heard.....	65
8.3.6	Symptom: A clapping sound is heard.....	65
8.3.7	Symptom: A faxing sound is heard when the front panel is fully open.....	65
8.3.8	Symptom: White mist comes out of a unit (Indoor unit, outdoor unit).....	65
8.3.9	Symptom: The units can give off odours.....	65
8.3.10	Symptom: The outdoor fan rotates while the air conditioner is not in operation.....	66
8.3.11	Symptom: Airflow rate setting does NOT resume when Comfort airflow is deactivated by ONECTA app.....	66
8.3.12	Symptom: The vertical automatic swing operation does NOT resume after the Comfort airflow operation is deactivated.....	66
8.3.13	Symptom: Some operation icons are not visible on the wireless remote control, or some functions cannot be activated in the ONECTA app.....	66
8.3.14	Symptom: In ONECTA app, powerful operation is NOT indicated as active.....	66
9	Disposal	67
10	Glossary	68

1 About the documentation

1.1 About this document

Thank you for purchasing this product. Please:

- Read the documentation carefully before operating the user interface to ensure the best possible performance.
- Request the installer to inform you about the settings that he used to configure your system. Check if he has filled in the installer settings tables. If NOT, request him to do so.
- Keep the documentation for future reference.

Target audience

End users



INFORMATION

This appliance is intended to be used by expert or trained users in shops, in light industry, and on farms, or for commercial and household use by lay persons.

Documentation set

This document is part of a documentation set. The complete set consists of:

- **General safety precautions:**
 - Safety instructions that you must read before operating your system
 - Format: Paper (in the box of the indoor unit)
- **Operation manual:**
 - Quick guide for basic usage
 - Format: Paper (in the box of the indoor unit)
- **User reference guide:**
 - Detailed step-by-step instructions and background information for basic and advanced usage
 - Format: Digital files on <https://www.daikin.eu>. Use the search function 🔍 to find your model.

Latest revisions of the supplied documentation may be available on the regional Daikin website or via your installer.

Scan the QR code below to find the full documentation set and more information about your product on the Daikin website.

FTXJ-AB9



FTXJ-AS9











FTXJ-AW9







The original instructions are written in English. All other languages are translations of the original instructions.

1.2 Meaning of warnings and symbols

	DANGER Indicates a situation that results in death or serious injury.
	DANGER: RISK OF ELECTROCUTION Indicates a situation that could result in electrocution.
	DANGER: RISK OF BURNING/SCALDING Indicates a situation that could result in burning/scalding because of extreme hot or cold temperatures.
	DANGER: RISK OF EXPLOSION Indicates a situation that could result in explosion.
	WARNING Indicates a situation that could result in death or serious injury.
	WARNING: FLAMMABLE MATERIAL
	CAUTION Indicates a situation that could result in minor or moderate injury.
	NOTICE Indicates a situation that could result in equipment or property damage.
	INFORMATION Indicates useful tips or additional information.

Symbols used on the unit:

Symbol	Explanation
	Before installation, read the installation and operation manual, and the wiring instruction sheet.
	Before performing maintenance and service tasks, read the service manual.
	For more information, see the installer and user reference guide.
	The unit contains rotating parts. Be careful when servicing or inspecting the unit.

Symbols used in the documentation:

Symbol	Explanation
	Indicates a figure title or a reference to it. Example: "▲ 1-3 Figure title" means "Figure 3 in chapter 1".

Symbol	Explanation
	Indicates a table title or a reference to it. Example: "☐ 1-3 Table title" means "Table 3 in chapter 1".

2 User safety instructions

Always observe the following safety instructions and regulations.

2.1 General



WARNING

If you are NOT sure how to operate the unit, contact your installer.



WARNING

This appliance can be used by children aged from 8 years and above and persons with reduced physical, sensory or mental capabilities or lack of experience and knowledge if they have been given supervision or instruction concerning use of the appliance in a safe way and understand the hazards involved.

Children SHALL NOT play with the appliance.

Cleaning and user maintenance SHALL NOT be made by children without supervision.



WARNING

To prevent electrical shocks or fire:

- Do NOT rinse the unit.
- Do NOT operate the unit with wet hands.
- Do NOT place any objects containing water on the unit.



CAUTION

- Do NOT place any objects or equipment on top of the unit.
- Do NOT sit, climb or stand on the unit.

- Units are marked with the following symbol:



This means that electrical and electronic products may NOT be mixed with unsorted household waste. Do NOT try to dismantle the system yourself: dismantling the system, treatment of the refrigerant, of oil and of other parts MUST be done by an authorised installer and MUST comply with applicable legislation.

Units MUST be treated at a specialised treatment facility for reuse, recycling and recovery. By ensuring this product is disposed of correctly, you will help to prevent potential negative consequences for the environment and human health. For more information, contact your installer or local authority.

- Batteries are marked with the following symbol:



This means that the batteries may NOT be mixed with unsorted household waste. If a chemical symbol is printed beneath the symbol, this chemical symbol means that the battery contains a heavy metal above a certain concentration.

Possible chemical symbols are: Pb: lead (>0.004%).

Waste batteries MUST be treated at a specialised treatment facility for reuse. By ensuring waste batteries are disposed of correctly, you will help to prevent potential negative consequences for the environment and human health.

2.2 Instructions for safe operation



A2L

WARNING: MILDLY FLAMMABLE MATERIAL

The refrigerant inside this unit is mildly flammable.



CAUTION

The indoor unit contains radio equipment, minimum separation distance between the radiating part of the equipment and the user is 10 cm.



CAUTION

Do NOT insert fingers, rods or other objects into the air inlet or outlet. When the fan is rotating at high speed, it will cause injury.

**WARNING**

- Do NOT modify, disassemble, remove, reinstall or repair the unit yourself as incorrect dismantling or installation may cause an electrical shock or fire. Contact your dealer.
- In case of accidental refrigerant leaks, make sure there are no naked flames. The refrigerant itself is entirely safe, non-toxic and mildly flammable, but it will generate toxic gas when it accidentally leaks into a room where combustible air from fan heaters, gas cookers, etc. is present. Always have qualified service personnel confirm that the point of leakage has been repaired or corrected before resuming operation.

**CAUTION**

ALWAYS use the wireless remote control or other user interface (if applicable) to adjust the position of the flaps and louvers. When the flaps and louvers are swinging and you move them forcibly by hand, the mechanism will break.

**CAUTION**

NEVER expose little children, plants or animals directly to the airflow.

**WARNING**

Do NOT place a flammable spray bottle near the air conditioner and do NOT use sprays near the unit. Doing so may result in a fire.

**CAUTION**

Do NOT operate the system when using a room fumigation-type insecticide. Chemicals could collect in the unit, and endanger the health of people who are hypersensitive to chemicals.



WARNING

- The refrigerant inside the unit is mildly flammable, but normally does NOT leak. If the refrigerant leaks in the room and comes in contact with fire from a burner, a heater, or a cooker, this may result in fire, or the formation of a harmful gas.
- Turn OFF any combustible heating devices, ventilate the room, and contact the dealer where you purchased the unit.
- Do NOT use the unit until a service person confirms that the part from which the refrigerant leaked has been repaired.



WARNING

- Do NOT pierce or burn refrigerant cycle parts.
- Do NOT use cleaning materials or means to accelerate the defrosting process other than those recommended by the manufacturer.
- Be aware that the refrigerant inside the system is odourless.



WARNING

The appliance shall be stored so as to prevent mechanical damage and in a well-ventilated room without continuously operating ignition sources (e.g. open flames, an operating gas appliance, or an operating electric heater). The room size shall be as specified in the General safety precaution.



DANGER: RISK OF ELECTROCUTION

To clean the air conditioner or air filter, be sure to stop operation and turn all power supplies OFF. Otherwise, an electrical shock and injury may result.



CAUTION

After a long use, check the unit stand and fitting for damage. If damaged, the unit may fall and result in injury.



CAUTION

Do NOT touch the heat exchanger fins. These fins are sharp and could result in cutting injuries.

**WARNING**

Be careful with ladders when working in high places.

**WARNING**

Improper detergents or cleaning procedure may cause damage on plastic components or water leakage. Splashed detergent on electric components, such as motors, may cause failure, smoke or ignition.

**DANGER: RISK OF ELECTROCUTION**

Before cleaning, be sure to stop the operation, turn the breaker OFF or pull out the supply cord. Otherwise, an electrical shock and injury may result.

**WARNING**

Stop operation and shut OFF the power if anything unusual occurs (burning smells etc.).

Leaving the unit running under such circumstances may cause breakage, electrical shock or fire. Contact your dealer.

3 About the system



A2L

WARNING: MILDLY FLAMMABLE MATERIAL

The refrigerant inside this unit is mildly flammable.



CAUTION

The indoor unit contains radio equipment, minimum separation distance between the radiating part of the equipment and the user is 10 cm.



NOTICE

Do NOT use the system for other purposes. In order to avoid any quality deterioration, do NOT use the unit for cooling precision instruments, food, plants, animals, or works of art.

3.1 Indoor unit



CAUTION

Do NOT insert fingers, rods or other objects into the air inlet or outlet. When the fan is rotating at high speed, it will cause injury.



INFORMATION

The sound pressure level is less than 70 dBA.



WARNING

- Do NOT modify, disassemble, remove, reinstall or repair the unit yourself as incorrect dismantling or installation may cause an electrical shock or fire. Contact your dealer.
- In case of accidental refrigerant leaks, make sure there are no naked flames. The refrigerant itself is entirely safe, non-toxic and mildly flammable, but it will generate toxic gas when it accidentally leaks into a room where combustible air from fan heaters, gas cookers, etc. is present. Always have qualified service personnel confirm that the point of leakage has been repaired or corrected before resuming operation.

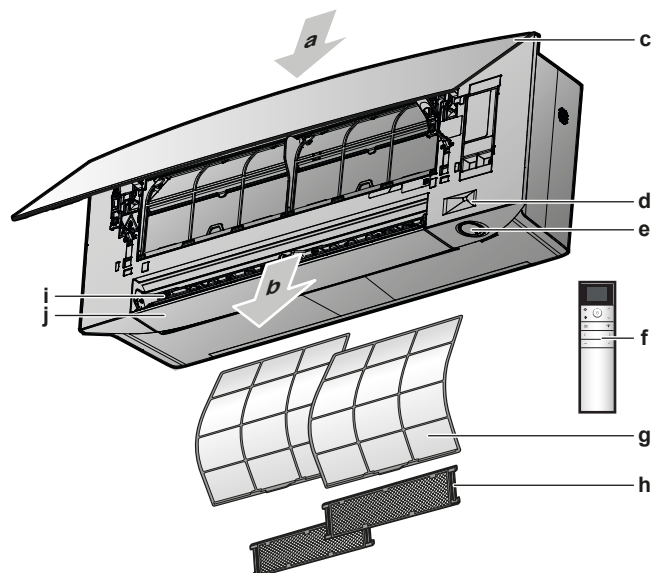

- a** Air inlet
- b** Air outlet
- c** Front panel
- d** Intelligent eye sensor
- e** ON/OFF button, Daikin eye and timer lamp
- f** User interface (wireless remote control)
- g** Air filter
- h** Titanium apatite deodorising filter and silver particle filter (Ag-ion filter) (with frame)
- i** Louvers (vertical blades)
- j** Flaps (horizontal blades)

ON/OFF button

If the user interface (e.g. wireless remote control) is missing, you can use the ON/OFF button on the indoor unit to start/stop operation. When operation is started using this button, the following settings are used:

- Operation mode = Automatic
- Temperature setting = 25°C
- Airflow rate = Automatic

3.1.1 Daikin eye indication lamp

The Daikin eye colour will change according to operation.

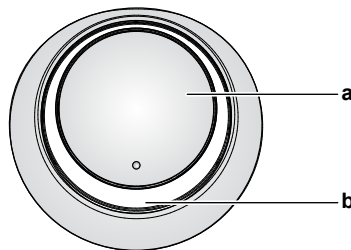

- a** ON/OFF button
- b** Daikin eye (with infrared signal receiver)

Operation	Daikin eye colour
Automatic	Red/blue
Cooling	Blue
Heating	Red
Fan only	White
Drying	Green
Timer operation	Orange ^(a)

^(a) When the OFF/ON timer or Weekly timer operation is set, the Daikin eye periodically changes to orange. After lighting orange for about 10 seconds, it returns to the colour of the operation mode for 3 minutes. **Example:** When the timer is set during cooling operation, the Daikin eye will periodically light orange for 10 seconds, and then switch to blue for 3 minutes.

3.2 About the user interface

Wireless remote control



INFORMATION

The indoor unit is delivered with the wireless remote control as the user interface. This manual describes only operation with this user interface. If another user interface is connected, refer to the operation manual of the connected user interface.

- **Direct sunlight.** Do NOT expose the wireless remote control to direct sunlight.
- **Dust.** Dust on the signal transmitter or receiver will reduce sensitivity. Wipe off dust with a soft cloth.
- **Fluorescent lights.** Signal communication might be disabled if fluorescent lamps are in the room. In that case, contact your installer.
- **Other appliances.** If the wireless remote control signals operate other appliances, move the other appliances, or contact your installer.
- **Curtains.** Make sure that curtains or other objects do NOT block the signal between the unit and the wireless remote control.



NOTICE

- Do NOT drop the wireless remote control.
- Do NOT let the wireless remote control get wet.

3.2.1 Components: Wireless remote control

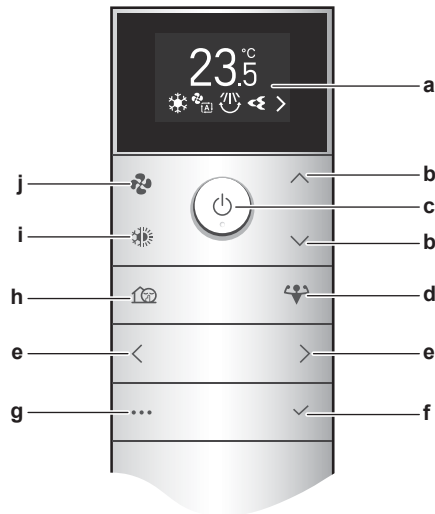

- a LCD display
- b Temperature up/down and menu navigation up/down buttons
- c ON/OFF button
- d Powerful operation button
- e Menu navigation left/right buttons
- f Confirm button
- g Main menu button
- h Outdoor unit silent operation
- i Mode selection button (automatic, cooling, heating, dry, fan only)
- j Airflow rate setting button

3.2.2 To operate the wireless remote control

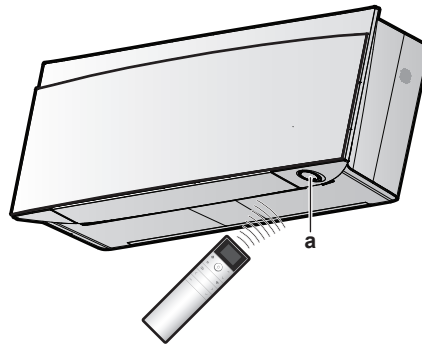

a Infrared signal receiver

Note: Make sure that there are no obstacles within 500 mm under the infrared signal receiver. They may influence reception performance of the wireless remote control.

- 1 Aim the signal transmitter at the infrared signal receiver on the indoor unit (maximum distance for communication is 7 m).

Result: When the indoor unit receives a signal from the wireless remote control, you will hear a sound:

Sound	Description
Beep-beep	Operation starts.
Beep	Setting changes.
Long beep	Operation stops.

3.2.3 Status: Wireless remote control LCD

Home screen

Home screen when the unit is ON



- a Current temperature setpoint
b Icons of active features

Home screen when the unit is OFF



The following features can be set when the unit is OFF; settings will be active when the unit is ON.

- Buttons: fan, operation modes, outdoor unit silent operation
- Menu: all menu features except ECONO operation.

Home screen during fan only and dry mode

During Fan only or Dry mode, the temperature setpoint is replaced by the Fan only or Dry icon.

Fan only mode



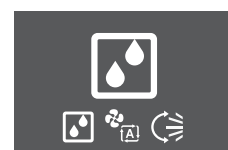

Dry mode



Icons of active features order





Depending on the currently set features, the icons will display in the following order on the bottom of the LCD (left to right):

Icon	Description
	Battery is low "4.1 To insert the batteries" [▶ 20]
	Econo or Powerful operation "5.7 Powerful operation" [▶ 40]
	Operation mode "5.3 Operation mode and temperature setpoint" [▶ 33]
	Airflow rate "5.4 Airflow rate" [▶ 34]
	Airflow direction "5.5 Airflow direction" [▶ 35]
	Flash Streamer (cleaning) operation "5.10 Flash Streamer (air cleaning) operation" [▶ 43]
	Outdoor unit silent operation "5.9 Outdoor unit quiet operation" [▶ 42]
	Intelligent eye operation "5.6 Intelligent eye operation" [▶ 39]
	Comfort operation "5.5 Airflow direction" [▶ 35]
	Weekly timer "5.11.3 Weekly timer operation" [▶ 47]
	On timer "5.11.2 OFF/ON timer operation" [▶ 45]

Icon	Description
	Off timer "5.11.2 OFF/ON timer operation" [▶ 45]
	More icons are active than can fit on the home screen. Use < or > to navigate through the icon list.

3.2.4 Main menu: Wireless remote control





General navigation principles

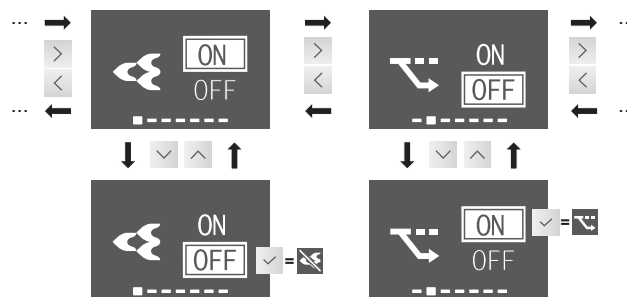

















Button	Function
	Menu button to enter/exit the main menu
	Left/right button for navigation through: <ul style="list-style-type: none"> ▪ icons on the home screen ▪ menus
	Up/down button for: <ul style="list-style-type: none"> ▪ temperature setting ▪ selection of setting (Example: ON → OFF)
	Confirm button to confirm a selection or to enter setting menus









Example:



Result: Confirming a selection will send you back to the home screen. The function icon will disappear/appear on the home screen.

Menu overview	
	Flash Streamer "5.10 Flash Streamer (air cleaning) operation" [▶ 43]
	Econo "5.8 Econo operation" [▶ 41] Remark:  (function is prohibited) displays on the screen when the operation is OFF or in Fan only mode.
	Intelligent eye "5.6 Intelligent eye operation" [▶ 39]
	Airflow direction setting menu "5.5 Airflow direction" [▶ 35]

Menu overview	
	Horizontal airflow (swing or fixed)
	Vertical airflow (swing or fixed)
	Comfort airflow operation Remark:  (function is prohibited) displays on the screen when the operation is OFF or in Fan only mode.
	Clock and timer setting menu "5.11 Clock and timer setting" [▶ 43]
	ON timer Remark: Displays only if the clock is set
	OFF timer Remark: Displays only if the clock is set
	Weekly timer Remark: Displays only if the clock is set
	Clock
	Indoor unit setting menu "4.4 Indoor unit setting" [▶ 21]
	Brightness of the Daikin eye
	Open the front panel when the unit is OFF Remark:  (function is prohibited) displays on the screen when the operation is ON. When the unit is in operation, the front panel opens automatically.
	Wireless LAN connection Remark:  (function is prohibited) displays on the screen when the operation is ON.
	Vertical airflow setting
	Position of the indoor unit
	Keep dry
	Wireless remote controller setting menu "4.5 Wireless remote control setting" [▶ 28]

Menu overview	
	Contrast of the wireless remote control LCD
	Brightness of the wireless remote control LCD
	Automatic LCD turn off time
	Automatic send after select interval
	Change the channel for the indoor unit infrared receiver to avoid confusion of the wireless remote control signal (Example: when 2 indoor units are installed in the same room)
	Software version and self-diagnosis menu
	Test run during commissioning (for the installer or service person)
	Error code indication by the wireless remote control "8.2 Solving problems based on error codes" [▶ 64]
	QR code for ONECTA app "To install the ONECTA app" [▶ 23]

4 Before operation

In this chapter

4.1	To insert the batteries	20
4.2	To mount the wireless remote control magnetic holder	21
4.3	To turn on the power supply	21
4.4	Indoor unit setting	21
4.4.1	Brightness of the Daikin eye	22
4.4.2	Open the front panel	22
4.4.3	Wireless LAN connection	22
4.4.4	Vertical airflow function	27
4.4.5	About indoor unit installation position	27
4.4.6	Keep dry	28
4.5	Wireless remote control setting	28
4.5.1	To set contrast of the LCD	29
4.5.2	To set brightness of the LCD	29
4.5.3	To set automatic LCD turn off time	29
4.5.4	To set automatic send after select	29
4.5.5	To set a different channel of the indoor unit infrared signal receiver	30

4.1 To insert the batteries

The batteries will last for about 1 year.

- 1 Remove the back cover.
- 2 Insert both batteries at once.
- 3 Put the cover back.

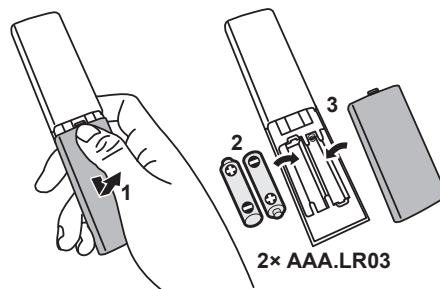

INFORMATION

- Low energy of battery indicates blinking **0** on the LCD display (first position).
- When the batteries are running low, functions of the wireless remote control are suspended and you can only turn OFF the operation, all timer functions are OFF. Replace the batteries as soon as possible.
- ALWAYS replace both batteries together.

4.2 To mount the wireless remote control magnetic holder

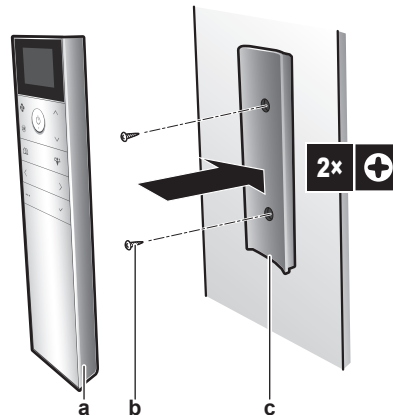

- a Wireless remote controller
- b Screws (field supply)
- c Wireless remote controller magnetic holder

- 1 Choose a place where the signals reach the unit.
- 2 Attach the holder with screws to the wall or a similar location.
- 3 Hang the wireless remote control on the holder.



INFORMATION

The wireless remote control holder is magnetic. Make sure to install the holder with the right side up.

4.3 To turn on the power supply

- 1 Turn the circuit breaker on.

Result: The flap of the indoor unit will open and close to set the reference position.

4.4 Indoor unit setting

- 1 Enter the main menu by pressing and navigate to the indoor unit setting menu using and . Press to enter the menu.

Indoor unit setting menu



- 2 Perform the settings listed below.
- 3 Press to return to the main menu or press to exit to the home screen.

Setting list

4.4.1	Brightness of the Daikin eye	22
4.4.2	Open the front panel	22
4.4.3	Wireless LAN connection	22
4.4.4	Vertical airflow function.....	27
4.4.5	About indoor unit installation.....	27
4.4.6	Keep dry	28

4.4.1 Brightness of the Daikin eye

You can set the brightness of the Daikin eye on the indoor unit to high, low or turn it OFF.

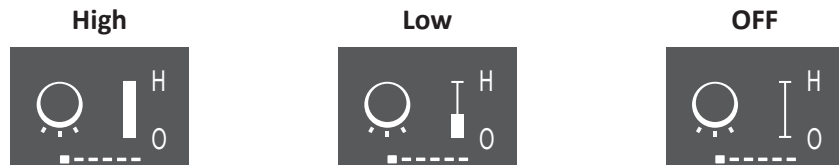

To set the brightness of the Daikin eye

- 1 In the indoor unit setting menu, navigate to the brightness of the Daikin eye setting screen using  and .



- 2 Change the setting using  and .



Result: The brightness of the Daikin eye changes.

- 3 Press  again to return to the main menu or press  to return to the home screen.

4.4.2 Open the front panel

The front panel opens automatically when the operation starts. When you want to open the front panel when the operation is OFF, use this feature. **Example:** during maintenance.

To open the front panel using the wireless remote control



- 1 Make sure the operation is OFF. If not, turn it OFF using .
- 2 In the indoor unit setting menu, navigate to the open the front panel screen using  and .

Open the front panel screen



- 3 Press  to confirm.

Result: The front panel opens.

- 4 Press  again to close the front panel or press  to return to the home screen.

4.4.3 Wireless LAN connection

Simply connect your unit to your home network and download the app to change the thermostat, set temperature schedules, review your energy consumption and more.

For details on specifications, setting methods, FAQ, troubleshooting tips, visit app.daikineurope.com.



The customer is responsible for providing:

- Smartphone or tablet with minimum supported version of Android or iOS, specified on app.daikineurope.com.
- Internet line and communication device, such as a modem, router, etc.
- Wireless LAN access point
- Installed free ONECTA application

Note: If needed, the SSID (Service Set Identifier) and the KEY (password) are located on the unit.

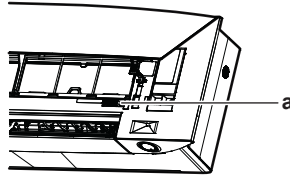

a Label with the SSID and the KEY

Precautions when using the wireless LAN

Do NOT use near:

- **Medical equipment.** E.g. persons using cardiac pacemakers or defibrillators. This product may cause electromagnetic interference.
- **Auto-control equipment.** E.g. automatic doors or fire alarm equipment. This product may cause faulty behaviour of the equipment.
- **Microwave oven.** It may affect wireless LAN communications.

To install the ONECTA app

- 1 Go to Google Play (for Android devices) or the App Store (for iOS devices) and search for "ONECTA".
- 2 Follow the directions on the screen to install the ONECTA app.

Search the app directly using the QR on the wireless remote control display

- 1 Enter the main menu by pressing and navigate to the wireless remote control setting menu using and .
- 2 Press to enter the menu.

Wireless remote control setting menu



- 3 Navigate to the QR code screen using and .
- 4 Scan the QR code by smartphone or other smart devices.

Result: The QR code will re-direct you to the App Store or Google Play.



- 5 Follow the directions on the screen to install.



INFORMATION

If the QR code is difficult to read, switch the displayed QR code using or , then try again.

To set the wireless connection

There are two options to connect the wireless adapter to your home network.

- Using a smart device (smartphone, tablet) and SSID (Service Set Identifier) and KEY (password)
- Using the WPS (Wi-Fi Protected Setup) button on your Wi-Fi router.

For more information and FAQ, refer to app.daikineurope.com.

Note: Setting is done by the wireless remote control in the wireless LAN setting menu. During setting, always aim the wireless remote control at the infrared signal receiver on the unit.



INFORMATION

Make sure operation is stopped before setting the wireless connection. Connection CANNOT be made when the unit is in operation.

- 1 **Stop operation** before setting the wireless connection.
- 2 Make sure the wireless router is close enough to the unit and nothing obstructs the signal.

Menu	Description
	<ul style="list-style-type: none"> ▪ ON = Wireless LAN ON (AP mode/RUN mode (SSID + KEY) connection setting) ▪ OFF = Wireless LAN OFF
	Exit to setting menu
	WPS connection setting
	Reset to factory default
	Connection status check

To connect the wireless LAN to your home network

The wireless adapter can be connected to your home network using the:

- WPS button (Wi-Fi Protected Setup) on the router (if present),
- The SSID (Service Set Identifier) and the KEY (password) - located on the unit.

- 1 In the indoor unit setting menu, navigate to the Wireless LAN connection setting using and . Press to enter the menu.

Indoor unit setting menu

Wireless LAN connection setting



- 2 Change the setting to ON using and . Press to confirm your selection.

Wireless LAN signal ON



Wireless LAN signal OFF



Result: The connection animation is displayed on the screen for 5 seconds and the wireless LAN status screen is displayed.

- 3 Continue setting using the WPS button or the SSID and KEY.

To connect using the WPS button

- 1 Navigate to WPS screen by and . Press to confirm selection.

Result: The Daikin eye colour alternates between orange and partly green.

WPS setting



- 2 Press the WPS button on your communication device (e.g. router) within approximately 1 minute. Refer to the manual of your communication device.

Result: If the connection was successful, the Daikin eye colour alternates between blue and partly green.



INFORMATION

If the connection with your router is not possible, try procedure "[To connect using SSID and KEY number](#)" [[▶ 25](#)].

- 3 Press to exit to the home screen or use EXIT screen to return to "indoor unit setting menu".

To connect using SSID and KEY number

- 1 Open the ONECTA app on your smart device and follow the steps on the screen.
- 2 Connect your smart device to the same home network as the unit.
- 3 Check if the connection was successful (refer to "[To confirm the wireless LAN connection status](#)" [[▶ 25](#)]).
- 4 Press to exit to the home screen or use EXIT screen to return to "indoor unit setting menu".

To confirm the wireless LAN connection status

- 1 Navigate to the status screen using and . Press to confirm.

Status screen



2 Check the Daikin eye.

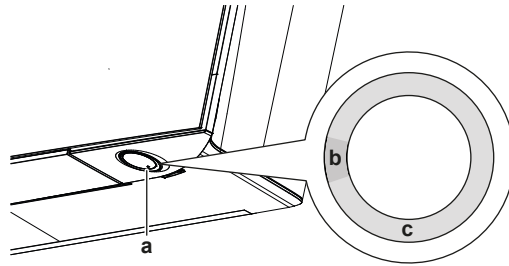

- a Daikin eye
- b Partly green
- c Red, orange or blue

Daikin eye colour alternates between partly green and...	...then wireless adapter is...
Red	not connected
orange	running and ready to connect to the home network via WPS button; see " To connect using the WPS button " [▶ 25].
blue	connected to the home network: <ul style="list-style-type: none"> ▪ via SSID + KEY. or ▪ via the WPS button on the router.

3 Press to exit to the home screen or use EXIT screen to return to the indoor unit setting menu.

To reset the connection setting to the factory default

Reset the connection setting to the factory default in case you want to:

- disconnect the wireless LAN and the communication device (e.g. router) or smart device.
- repeat the setting if the connection was unsuccessful.

1 Navigate to the RESET screen using and . Press to confirm your selection.

Result: The setting is reset to the factory default.

Reset screen



2 Press to exit to the home screen or use EXIT screen to return to the indoor unit setting menu.

To turn off the wireless LAN connection

1 Enter the wireless LAN connection setting menu and change the setting to OFF using and . Press to confirm your selection.

Result: The Daikin eye alternates between green and white. Communication is OFF.

4.4.4 Vertical airflow function

This function helps with optimal airflow and temperature distribution in heating operation mode. You can turn this function OFF in case there is furniture or another object under the unit.

Vertical airflow OFF



Vertical airflow ON

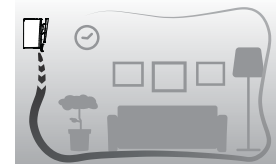

To turn ON/OFF vertical airflow function

- 1 In the indoor unit setting menu, navigate to the vertical airflow setting using **<** and **>**.

Vertical airflow function ON



Vertical airflow function OFF



- 2 Change the setting using **^** and **v**.
- 3 Press **v** to confirm your selection.
- 4 Press **v** again to return to the main menu or press **...** to return to the home screen.

4.4.5 About indoor unit installation position

When the indoor unit is installed close to a wall on one side, change this setting to avoid direct airflow to walls.

To change indoor unit position setting



- 1 In the indoor unit setting menu, navigate to the indoor unit position setting using **<** and **>**. Press **v** to enter the setting.



Indoor unit position setting

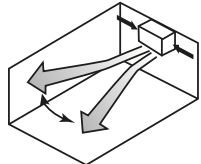

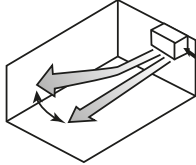
- 2 Select the setting according to the installation position using **<** and **>**. Then confirm using **v**.

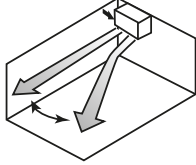
If the unit is...	Setting	Result
In the middle of the wall (factory default setting)		

If the unit is...	Setting	Result
≤500 mm from the wall on right		
≤500 mm from the wall on left		

- Press  again to return to the main menu or press  to return to the home screen.

4.4.6 Keep dry

When the unit reaches the temperature setpoint during cooling operation, the fan will go OFF to avoid increasing the room humidity. If you want to keep the fan running, disable this function.

To turn ON/OFF keep dry function

- In the indoor unit setting menu, navigate to the keep dry setting using  and .





Keep dry function ON





Keep dry function OFF



- Result: The fan stops** after the unit has reached the temperature setpoint in cooling operation.
- Result: The fan runs** even after the unit has reached the temperature setpoint in cooling operation.



- Change the setting using  and .
- Press  to confirm your selection.
- Press  again to return to the main menu or press  to return to the home screen.

4.5 Wireless remote control setting

- Enter the main menu by pressing  and navigate to the wireless remote control setting menu using  and . Press  to enter the menu.

Wireless remote control setting menu





- Perform the settings listed below.
- Press  to return to the main menu or press  to exit to the home screen.

Setting list

4.5.1	To set contrast of the LCD	29
4.5.2	To set brightness of the LCD	29
4.5.3	To set automatic LCD turn off time	29
4.5.4	To set automatic send after select	29
4.5.5	To set a different channel of the indoor unit infrared signal receiver	30



4.5.1 To set contrast of the LCD

- 1 In the wireless remote control setting menu, navigate to the contrast of the LCD setting screen using  and .

Lowest contrast setting**Highest contrast setting**

- 2 Change the contrast setting using  and  (6 levels).



4.5.2 To set brightness of the LCD

- 1 In the wireless remote control setting menu, navigate to the LCD brightness setting using  and .



Lowest brightness setting**Highest brightness setting**

- 2 Change the brightness setting using  and  (6 levels).



4.5.3 To set automatic LCD turn off time

- 1 In the wireless remote control setting menu, navigate to the LCD turn off time setting using  and .

The display will turn OFF after 5 seconds**The display will turn OFF after 20 seconds**

- 2 Change the setting using  and . Minimum is 5 seconds and maximum is 20 seconds. The value changes by 5 seconds with each step.

4.5.4 To set automatic send after select

- 1 In the wireless remote control setting menu, navigate to the automatic send after select setting using  and .





Minimum: 0 seconds**Maximum: 3 seconds**

- 2 Change the setting using  and . Minimum is 0 seconds and maximum is 3 seconds. The value changes by 1 second with each step.

4.5.5 To set a different channel of the indoor unit infrared signal receiver

In case 2 indoor units are installed in 1 room, you can change the channel for the infrared signal receiver on the indoor unit to avoid the wireless remote control signal confusion.

Prerequisite: Perform the following setting for only 1 of the units.

- 1 In the wireless remote control settings menu, navigate to the channel selection setting using  and .
- 2 Change the setting to **channel 2** using  and .

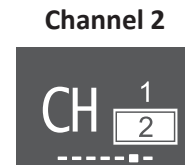

- 3 Confirm your selection using .

Result: The Daikin eye will start to blink.

- 4 Press the indoor unit ON/OFF switch while the Daikin eye is blinking.

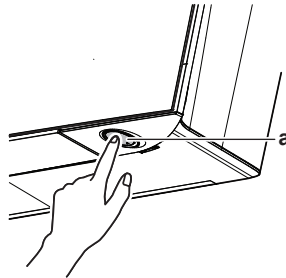

a ON/OFF switch



INFORMATION

If the setting could NOT be completed while the Daikin eye was blinking, repeat the setting process from the beginning.

5 Operation



INFORMATION

The indoor unit is delivered with the wireless remote control as the user interface. This manual describes only operation with this user interface. If another user interface is connected, refer to the operation manual of the connected user interface.

5.1 Operation range

Use the system in the following temperature and humidity ranges for safe and effective operation.





	Cooling and drying ^{(a)(b)}	Heating ^(a)
Outdoor temperature for RXJ models	-10~50°C DB	-20~24°C DB -21~18°C WB
Outdoor temperature for 2MXM, 3MXM, 4MXM, 5MXM models	-10~46°C DB	-15~24°C DB -15~18°C WB
Indoor temperature	18~37°C DB 14~28°C WB	10~30°C DB
Indoor humidity	≤80% ^(a)	—















^(a) A safety device might stop the operation of the system if the unit runs outside its operation range.



^(b) Condensation and water dripping might occur if the unit runs outside its operation range.

5.2 When to use which feature

You can use the following table to determine which features to use:

Basic feature	
Automatic 	"5.3 Operation mode and temperature setpoint" [▶ 33] To start/stop the system and to set the temperature:
Cooling 	<ul style="list-style-type: none"> In automatic mode, an appropriate temperature and operation mode is automatically selected. In cooling mode, cool down a room.
Heating 	<ul style="list-style-type: none"> In heating mode, heat up a room. In fan only mode, blow air in a room without heating or cooling.
Fan only 	<ul style="list-style-type: none"> In drying mode, decrease the humidity in a room.
Drying 	

Basic feature	
Vertical  Horizontal  3D (all directions)  Comfort 	<p>"5.5 Airflow direction" [▶ 35]</p> <p>To adjust the airflow direction (swing or fixed position).</p> <p>Comfort airflow operation: To automatically adjust the airflow direction to cool down or heat up the room more effectively.</p>
Automatic  Night quiet  Airflow rate setting  	<p>"5.4 Airflow rate" [▶ 34]</p> <p>To adjust the amount of air blown into the room.</p> <p>To run more quietly.</p>
Advanced features	
	<p>"5.10 Flash Streamer (air cleaning) operation" [▶ 43]</p> <p>To remove airborne allergens such as pollen, adjuvant substances...</p> <p>To reduce bad odours.</p>
	<p>"5.8 Econo operation" [▶ 41]</p> <p>To use the system when you are also using other power-consuming appliances.</p> <p>To save energy.</p>
	<p>"5.7 Powerful operation" [▶ 40]</p> <p>To cool down or heat up the room quickly.</p>
	<p>"5.9 Outdoor unit quiet operation" [▶ 42]</p> <p>To decrease the noise level of the outdoor unit. Example: At night.</p>
	<p>"5.6 Intelligent eye operation" [▶ 39]</p> <p>To prevent the air from coming in direct contact with people.</p> <p>To save energy when nobody is in the room.</p>
	<p>"4.4.6 Keep dry" [▶ 28]</p> <p>To avoid increasing the room humidity.</p>





Timer features	
	"5.11.2 OFF/ON timer operation" [▶ 45] To automatically turn ON or OFF the system.
	"5.11.3 Weekly timer operation" [▶ 47] To automatically turn ON or OFF the system on a weekly basis.
Special features	
	"4.4.3 Wireless LAN connection" [▶ 22] To operate the unit using smart devices

5.3 Operation mode and temperature setpoint

When. Adjust the system operation mode and set the temperature when you want to:

- Heat up or cool down a room
- Blow air in a room without heating or cooling
- Decrease the humidity in a room

What. The system operates differently, depending on the user selection.

Setting	Description
Automatic 	The system cools down or heats up a room to the temperature setpoint. It automatically switches between cooling and heating if necessary.
Cooling 	The system cools down a room to the temperature setpoint.
Heating 	The system heats up a room to the temperature setpoint. Heat boost This feature is automatic; it quickly heats up your home when starting up the unit in heating mode.
Fan only 	The system only controls the airflow (airflow rate and airflow direction). During this operation you CANNOT set the temperature.
Drying 	The system decreases the humidity in the room. During this operation you CANNOT set the temperature.

Additional info:

- **Outside temperature.** The system's cooling or heating effect decreases when the outside temperature is too high or too low.
- **Defrost operation.** During heating operation, frost might occur on the outdoor unit and decrease the heating capacity. In that case, the system automatically switches to defrosting operation to remove the frost. During defrosting operation, hot air is NOT blown from the indoor unit.
- **Humidity sensor.** Control the humidity by decreasing the humidity during cooling process.

5.3.1 To start/stop operation mode and to set the temperature

Operation mode

- 1 Press to enter the operation mode carousel menu. When is pressed repeatedly, the mode will change as follows:



i **INFORMATION**

- In the carousel menu, you can also navigate in both directions using and or and .
- The carousel menu will always start with the currently active setting.

- 2 Press to **start** operation.
- 3 The home screen changes as follows and the Daikin eye indication lamp goes ON.

Home screen when unit is ON during...		
heating, cooling, automatic operation	drying operation	fan only operation

Temperature setpoint

- 4 Press or one or more times to lower or raise the **temperature setpoint**.

Cooling operation	Heating operation	Automatic operation	Drying or fan only operation
18~32°C	10~30°C	18~30°C	No setpoint ^(a)

^(a) When using **drying** or **fan only** operation mode, you CANNOT adjust the temperature.

- 5 Press to **stop** operation.

Result: The home screen changes as follows and the Daikin eye indication lamp goes OFF.

Home screen when the unit is OFF





5.4 Airflow rate

i **INFORMATION**

- When using drying operation mode, you CANNOT adjust the airflow rate setting.
- The airflow rate in heating mode will lower to avoid generating cold airflow. When temperature of the airflow rise, operation will continue at the set airflow rate.

You can adjust the strength of the airflow coming out of the indoor unit.

Setting	Description
Fan speed 1~5 	5 airflow rate levels from low to high.
Automatic 	The indoor unit adjusts its fan speed automatically according to the setpoint and indoor temperature.
Indoor unit quiet operation 	For reduction of noise coming from the indoor unit (Example: at night)





INFORMATION

If the unit reaches the temperature setpoint:





- in cooling or automatic mode. Fan will stop operating.
- in heating mode. Fan will operate in low airflow rate.

5.4.1 To adjust the airflow rate

- Press  to enter the airflow rate carousel menu. When  is pressed repeatedly, the mode will change as follows:





INFORMATION

- In the carousel menu, you can also navigate in both directions using  and  or  and .
- The carousel menu will always start with the currently active setting.

5.5 Airflow direction

The airflow direction is the direction in which the indoor unit blows its air. It does so by moving horizontal blades (flaps) or vertical blades (louvers). Adjust the airflow direction as desired and in swing or in fixed position.

Setting	Airflow direction
Vertical automatic swing 	Moves the horizontal blades (flaps) up and down.
Horizontal automatic swing 	Moves the vertical blades (louvers) from side to side.
3-D airflow direction 	Moves alternately up and down and from side to side

Setting	Airflow direction
[—]	Stays in a fixed position.

 **CAUTION**
 ALWAYS use the wireless remote control or other user interface (if applicable) to adjust the position of the flaps and louvers. When the flaps and louvers are swinging and you move them forcibly by hand, the mechanism will break.

The movable range of the flap varies according to the operation mode. The flap will stop at the upper position when the airflow rate is changed to low during the up and down swing setting.

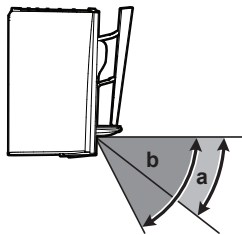

- a Flap range in cooling or drying operation
- b Flap range in heating or fan only operation

Comfort airflow

The unit will automatically change the direction of the airflow to heat up or cool down the room more effectively. Direct airflow from the unit will be less noticeable.

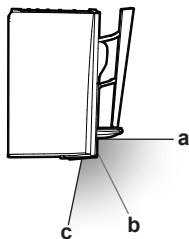

- a Flap position in cooling and dry operation
- b Flap position in heating operation (**vertical airflow OFF**)
- c Flap position in heating operation (**vertical airflow ON**)

In cooling and drying

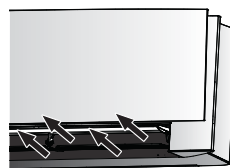

The airflow direction will change to spread the air along the ceiling.

Comfort airflow active

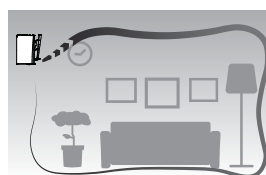

Comfort airflow disabled

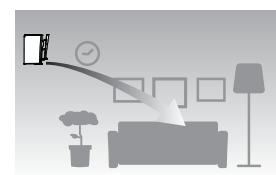

In heating

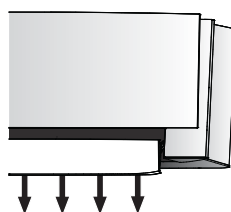

The airflow direction will change to spread the air along the floor.

If the Vertical airflow function is ON: The unit detects the room and floor temperature and automatically selects 1 of the 3 airflow directions (space warming, downward, vertical).

If the Vertical airflow function is OFF: The unit will operate only in downward airflow direction.

Space warming airflow	Downward airflow	Vertical airflow



INFORMATION

If you want to deactivate the Vertical airflow function (e.g. in case there is furniture or another object under the unit), refer to "To turn ON/OFF vertical airflow function" [▶ 27]. If the Vertical airflow function is deactivated, the airflow will be set to downward direction.



INFORMATION

Powerful and Comfort airflow operation CANNOT be used at the same time. The last selected function takes priority. If the vertical automatic swing is selected, Comfort airflow operation will be cancelled.

- 1 Enter the main menu by pressing and navigate to the airflow direction setting menu using and . Press to enter the menu.

Airflow direction setting menu



- 2 In this menu, perform the following airflow settings. Then press to return to the main menu or press to exit to the home screen.

Setting list

5.5.1	To adjust vertical airflow direction	37
5.5.2	To adjust horizontal airflow direction	38
5.5.3	To use 3D airflow direction	38
5.5.4	To start/stop Comfort airflow operation	39

5.5.1 To adjust vertical airflow direction

- 1 In the airflow direction setting menu, navigate to the vertical airflow screen using and .
- 2 Change the setting using and .

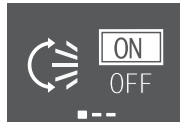
Vertical airflow - swing**Vertical airflow - fixed**

- 3 For vertical swing.** Press to confirm your selection.

Result: appears on the bottom of the home screen. The flaps (horizontal blades) will begin to swing.

- 4 For fixed position.** Press when the flaps reach the desired position.

Result: disappears from the bottom of the home screen. The flaps will stop moving.

5.5.2 To adjust horizontal airflow direction

- In the airflow direction setting menu, navigate to the horizontal airflow screen using and .
- Change the setting using and .

Horizontal airflow - swing**Horizontal airflow - fixed**

- 3 For horizontal swing.** Press to confirm your selection.

Result: appears on the bottom of the home screen. The louvers (vertical blades) will begin to swing.

- 4 For fixed position.** Press when the louvers reach the desired position.

Result: disappears from the bottom of the home screen. The louvers will stop moving.

**INFORMATION**

When the unit is installed in a corner of a room, the direction of the louvers should be facing away from the wall. Efficiency will drop if a wall blocks the air.

5.5.3 To use 3D airflow direction



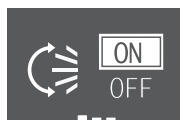

- Set the vertical and the horizontal airflow to ON.
- 3D** appears on the bottom of the home screen. The flaps (horizontal blades) and louvers (vertical blades) will begin to swing.

Vertical airflow ON**Horizontal airflow ON**

- To use fixed position, set the vertical and the horizontal airflow to OFF when the flaps and louvers reach the desired position.

Result: **3D** disappears from the bottom of the home screen. The flaps and the louvers will stop moving.

5.5.4 To start/stop Comfort airflow operation

- 1 In the airflow direction setting menu, navigate to the comfort airflow screen using  and .
- 2 Change the setting using  and .

Comfort airflow active

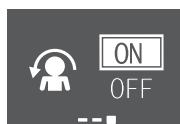

Comfort airflow disabled

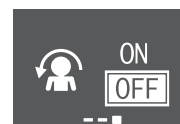

- 3 Press  to confirm your selection.

Result: Comfort airflow active:  appears on the bottom of the home screen.

Result: Comfort airflow disabled:  disappears from the bottom of the home screen.

5.6 Intelligent eye operation

The system detects movement in the room and automatically adjusts the airflow direction and temperature in order to avoid direct contact with people. If no movement is detected for 20 minutes, the system switches to energy saving operation:

Operation	Energy saving operation
Heating	Temperature is lowered by 2°C.
Cooling and drying	If the temperature in the room is: <ul style="list-style-type: none"> ▪ <30°C, the temperature is raised by 2°C ▪ ≥30°C, the temperature is raised by 1°C
Fan only	Decreases airflow rate.

About the Intelligent eye sensor



NOTICE

- Do NOT hit or push the Intelligent eye sensor. Doing so may lead to malfunction.
- Do NOT place large objects near the Intelligent eye sensor.





INFORMATION

Night set mode (OFF timer) CANNOT be used at the same time with Intelligent eye operation.

- **Detection range.** Up to 9 m.
- **Detection sensitivity.** Changes according to location, the number of persons in the room, temperature range, etc.
- **Detection mistakes.** The sensor may mistakenly detect pets, sunlight, moving curtains, etc.

5.6.1 To start/stop Intelligent eye operation

- 1 Press  to enter the main menu and navigate to the intelligent eye screen using  and .

- 2 Change the setting using  and .

Intelligent eye active



Intelligent eye disabled



- 3 Press  to confirm your selection.

Result: Intelligent eye active:  appears on the bottom of the home screen.

Result: Intelligent eye disabled:  disappears from the bottom of the home screen.

5.7 Powerful operation

This operation quickly maximizes the cooling/heating effect in any operation mode. You can get the maximum capacity.

Mode	Airflow rate
Cooling/Heating	<ul style="list-style-type: none"> To maximize the cooling/heating effect, the capacity of outdoor unit is increased. The airflow rate is fixed to the maximum setting. The temperature and airflow settings CANNOT be changed.
Drying	<ul style="list-style-type: none"> The temperature setting is lowered by 2.5°C. The airflow rate is slightly increased.
Fan only	The airflow rate is fixed to the maximum setting.







INFORMATION

Powerful operation CANNOT be used together with Econo, Comfort airflow and Outdoor unit quiet operation. The last selected function takes priority.

Powerful operation will NOT increase the capacity of the unit if it already operates at maximum capacity.



5.7.1 To start/stop Powerful operation

- Press  to enter the powerful operation pop-up menu.
- Press  or  and  to activate or disable the function.

Result: Powerful operation active:  appears on the bottom of the home screen.

Result: Powerful operation disabled:  disappears from the bottom of the home screen.

Powerful operation active**Powerful operation disabled****INFORMATION**

- Powerful operation can be set only when the unit is running; the  symbol on the screen indicates that the function is currently prohibited.
- If you press  or if you change the operation mode, operation will be cancelled;  disappears from the bottom of the home screen.

5.8 Econo operation

This is a function which enables efficient operation by limiting the maximum power consumption value. This function is useful for cases in which attention should be paid to ensure a circuit breaker will not trip when the product runs alongside other appliances.

**INFORMATION**



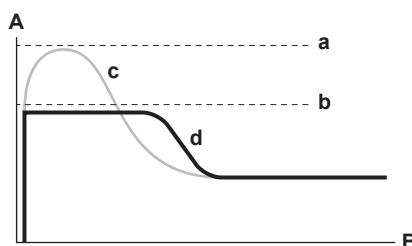

- Powerful and Econo operation CANNOT be used at the same time. The last selected function takes priority.
- Econo operation reduces power consumption of the outdoor unit by limiting the rotation speed of the compressor. If power consumption is already low, Econo operation will NOT further reduce power consumption.



- A** Running current and power consumption
- B** Time
- a** Maximum during normal operation
- b** Maximum during Econo operation
- c** Normal operation
- d** Econo operation

- The diagram is for illustrative purposes only.
- The maximum running current and power consumption of the air conditioner in Econo operation varies with the connected outdoor unit.

5.8.1 To start/stop Econo operation

- 1 Press  to enter the main menu and navigate to the Econo screen using  and .
- 2 Change the setting using  and .

Econo operation active**Econo operation disabled**

- 3 Press to confirm your selection.

Result: Econo operation **active:** appears on the bottom of the home screen.

Result: Econo operation **disabled:** disappears from the bottom of the home screen.

**INFORMATION**

- Econo operation can be set only when the unit is running; the on the screen indicates that function is currently prohibited.
- If you press , change the operation mode to fan only or set Powerful operation, Econo operation will be cancelled; disappears from the bottom of the home screen.

5.9 Outdoor unit quiet operation

Use Outdoor unit quiet operation when you want to decrease the noise level of the outdoor unit. **Example:** At night.

**INFORMATION**

- Powerful and Outdoor unit quiet operation CANNOT be used at the same time. The last selected function takes priority.
- This function is only available in Automatic, Cooling, and Heating operation.
- Outdoor unit quiet operation limits the rotation speed of the compressor. If the rotation speed of compressor is already low, Outdoor unit quiet operation will NOT further reduce the compressor rotation speed.

5.9.1 To start/stop Outdoor unit quiet operation

- 1 Press to enter the outdoor unit quiet operation pop-up menu.

Outdoor unit quiet operation active**Outdoor unit quiet operation disabled**

- 2 Press or and to activate or disable the function.

Result: Outdoor unit quiet **active:** appears on the bottom of the home screen.

Result: Outdoor unit quiet **disabled:** disappears from the bottom of the home screen.

Note: remains on the home screen, even if you turn off the unit using the wireless remote control or indoor unit ON/OFF switch.

5.10 Flash Streamer (air cleaning) operation

Streamer generates a high-speed electron stream with a high oxidizing power, reducing bad odours. Together with the titanium apatite deodorising filter and the air filters, this function cleans the air in the room.



INFORMATION

- The high-speed electrons are generated and go away inside the unit to ensure safe operation.
- The Streamer discharge may generate a fizzing sound.
- If the airflow becomes weak, the Streamer discharge may stop temporarily to prevent ozone smell.

5.10.1 To start/stop Flash Streamer (air cleaning) operation

- 1 Press to enter the main menu. The Flash Streamer screen is on the first position of the main menu.
- 2 Change the setting using and .

Flash Streamer operation active

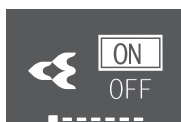

Flash Streamer operation disabled

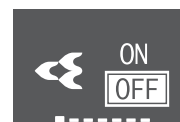

- 3 Press to confirm your selection.

Result: Flash streamer operation **active:** appears on the bottom of the home screen.

Result: Flash streamer operation **disabled:** disappears from the bottom of the home screen.

5.11 Clock and timer setting

- 1 Enter the main menu by pressing and navigate to the clock and timer setting menu using and . Press to enter the menu.

Clock and timer setting menu



- 2 In this menu, perform the following clock and timer setting. Then press to return to the main menu or press to exit to the home screen.

Setting list



5.11.1	The clock setting	43
5.11.2	OFF/ON timer operation	45
5.11.3	Weekly timer operation	47

5.11.1 The clock setting

If the indoor unit's internal clock is NOT set to the correct time, the ON timer, OFF timer and weekly timer will NOT operate correctly. The clock must be set again:

- After a circuit breaker has turned the unit OFF.
- After a power failure.
- After replacing batteries in the wireless remote control.

To set the clock

- 1 In the clock and timer setting menu, navigate to the clock setting screen using  and . Enter the setting using .

Clock setting (displays current clock setting)



Note: If the time was not yet set, you will first enter the clock setting. No other timer setting can be done until the clock is set.

- 2 Change the day of the week using  and .

Day of the week setting





Display	Day of the week
MON	Monday
TUE	Tuesday
WED	Wednesday
THU	Thursday
FRI	Friday
SAT	Saturday
SUN	Sunday

- 3 Go to the hours setting using .

Hours setting



- 4 Change the hour using  and  (24-hour format).
- 5 Go to the minutes setting using .

Minutes setting



- 6 Change the minutes using  and .

5.11.2 OFF/ON timer operation

Timer functions are useful for automatically switching the air conditioner off/on at night or in the morning. You can also use OFF timer and ON timer in combination.

**INFORMATION**

Program the timer again in case of:

- A breaker has turned the unit off.
- A power failure.
- After replacing batteries in the wireless remote control, the remote control keeps the time setting for the ON/OFF timer, but the timer is cancelled.

**INFORMATION**

The clock **MUST** be set correctly before using any timer functions. Refer to ["To set the clock" \[▶ 44\]](#).

To start/stop OFF timer operation

- 1 In the clock and timer setting menu, navigate to the OFF timer screen using and .

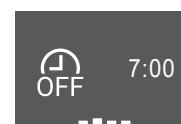
OFF timer disabled**OFF timer set to 7:00**

- 2 Press to enter the OFF timer setting menu.

Result: When setting the OFF timer for the first time, the current time rounded up to a 10-minute interval is displayed.

Result: When the OFF timer was already set, the last setting is displayed.
- 3 Change CANCEL to TIME using .
- 4 Go to the hour setting using and change the hour setting using and in 24-hour format.
- 5 Go to the minutes setting using and change the minutes setting using and in 10-minute intervals.

Change CANCEL to TIME**Set hours****Set minutes**

- 6 Press to confirm your selection.

Result: appears on the bottom of the home screen. The set time is displayed on the OFF timer screen in the main menu. The Daikin eye lights orange. The unit will turn OFF after the set time.
- 7 **To cancel** the timer setting, go to the OFF timer setting menu and change TIME to CANCEL.

Result: disappears from the bottom of the home screen. No time is displayed on the OFF timer screen in the main menu. The Daikin eye stops lighting orange.

**INFORMATION**

When you set the ON/OFF timer, the time setting is stored in the memory. When the wireless remote control batteries are replaced, the remote control keeps the time setting for the ON/OFF timer, but the timer is cancelled.

Night set mode

When the OFF timer is set, the air conditioner automatically adjusts the temperature setting (0.5°C up in cooling, 2.0°C down in heating) to prevent excessive cooling/heating and ensure a comfortable sleeping temperature.

To start/stop ON timer operation

- 1 In the clock and timer setting menu, navigate to the ON timer screen using and .

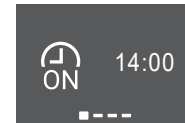
ON timer disabled**ON timer set to 14:00**

- 2 Press to enter the ON timer setting menu.

Result: When setting the ON timer for the first time, the current time rounded up to a 10-minute interval is displayed.

Result: When the ON timer was already set, the last setting is displayed.
- 3 Change CANCEL to TIME using .
- 4 Go to the hour setting using and change the hour setting using and in 24-hour format.
- 5 Go to the minutes setting using and change the minutes setting using and in 10-minute intervals.

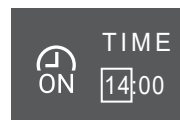
Change CANCEL to TIME**Set hours****Set minutes**

- 6 Press to confirm your selection.



Result: appears on the bottom of the home screen. The set time is displayed on the ON timer screen in the main menu. The Daikin eye lights orange. The unit will turn ON after the set time.
- 7 To cancel the timer setting, go to the ON timer setting menu and change TIME to CANCEL.

Result: disappears from the bottom of the home screen. No time is displayed on the ON timer screen in the main menu. The Daikin eye stops lighting orange.

To combine OFF timer and ON timer

- 1 To set the timers, refer to "[To start/stop OFF timer operation](#)" [▶ 45] and "[To start/stop ON timer operation](#)" [▶ 46].

Result: and are displayed on the bottom of the home screen.

Example:			
Display	Current time	Set while...	Operation
 	6:00	the unit is operating.	Stops at 7:00 and starts at 14:00.
		the unit is NOT operating.	Starts at 14:00.

5.11.3 Weekly timer operation

With this operation, you can save up to 4 timer settings for each day of the week.

Example: Create a different setting from Monday to Friday and a different setting for weekends.



INFORMATION

The following setting procedure is for the wireless remote control only. However, we recommend to perform the weekly timer setting using the ONECTA app. Refer to "[4.4.3 Wireless LAN connection](#)" [▶ 22] for more information.

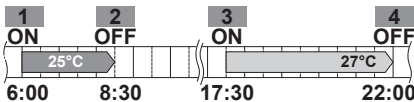
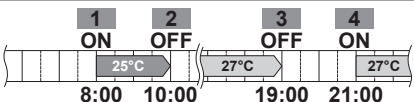
Day of the week	Setting example
Monday~Friday <ul style="list-style-type: none"> Make up to 4 settings for each day. 	
Saturday <ul style="list-style-type: none"> No timer setting 	—
Sunday <ul style="list-style-type: none"> Make up to 4 settings. 	

- **ON-ON-ON-ON setting.** Enables scheduling and set temperature.
- **OFF-OFF-OFF-OFF setting.** Only the turn off time can be set for each day.

Note: Be sure to aim the wireless remote control at the indoor unit and check for a receiving tone when setting the Weekly timer operation.



INFORMATION

The clock **MUST** be set correctly before using any timer functions. Refer to "[To set the clock](#)" [▶ 44].



INFORMATION

- Weekly timer and OFF/ON timer operation **CANNOT** be used at the same time. The OFF/ON timer operation takes priority. Weekly timer will be in standby,  disappears from the home screen. When the OFF/ON timer is completed, the Weekly timer becomes active.
- The day of the week, OFF/ON timer mode, time and temperature (only for ON timer) can be set with the Weekly timer. Other settings are based on previous ON timer setting.

To set Weekly timer operation

- 1 In the clock and timer setting menu, navigate to the weekly timer settings menu using and .
- 2 Change OFF to ON using and , then press to confirm your selection.

Result: The Daikin eye lights orange. Settings for the first day of the week will display (4 entries for each day).

Weekly timer disabled



Weekly timer active

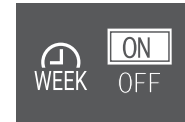

- 3 Navigate between days using and . Navigate between 4 entries using and .

Example:

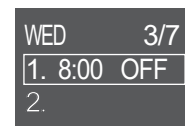
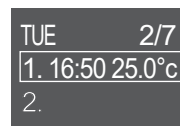

Empty field – no setting for Monday

Unit **starts:** on Tuesday at 16:50 with 25°C temperature setpoint

Unit **stops:** on Wednesday at 8:00

- 4 Press to enter the setting.
- 5 Change the setting to ON, OFF or DEL.

ON timer

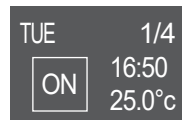

OFF timer



Delete



The unit starts at set time and temperature setpoint.

The unit stops at set time.

Deletes this entry

ON/OFF timer

- 6 Go to the hour setting using and change the hour setting using and in 24-hour format.
- 7 Go to the minutes setting using and change the minutes setting using and in 10-minute intervals.
- 8 **For OFF timer.** Confirm the setting using .

Result: The day of the week with 4 day entries is displayed. The new entry is present in the entry list. The unit turns ON or OFF at the set time. The entry list is sorted by time.

- 9 **For ON timer,** you can also set the temperature setpoint. Go to the temperature setting using and change the setpoint using and . Confirm the setting using .

Result: The day of the week with 4 day entries is displayed. The new entry is present in the entry list. The unit starts operating with the temperature setpoint. The entry list is sorted by time.

**INFORMATION**

The temperature can be set between 10~32°C on the wireless remote control, however:

- in cooling and automatic operation mode, the unit will operate at minimum 18°C, even if is set to 10~17°C;
- in heating and automatic operation mode, the unit will operate at maximum 30°C, even if is set to 31~32°C.

Delete entry

- 1 To delete individual entries, change the setting to DEL and confirm using

Result: The day of the week with 4 day entries is displayed. The entry is deleted. The day entry list is sorted by time.

5.12 About Multi system

In Multi system, 1 outdoor unit is connected to multiple indoor units. **Example:**

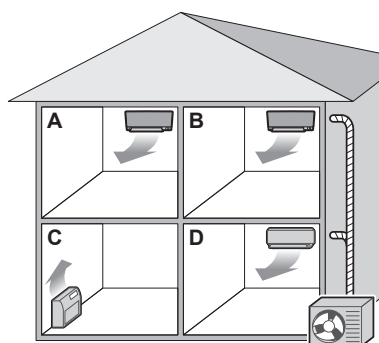

5.12.1 Priority room setting

Priority room setting requires initial programming during installation. Please consult your authorized dealer for assistance.

When priority room setting is inactive or not present

When more than 1 indoor unit is operating, priority is given to the first unit that was turned on. Set other units to the same operation mode. Otherwise, they will enter the standby mode, and the Daikin eye will flash (does NOT indicate malfunction).



Exceptions: If the first unit that was turned on is set to **fan only**, and then in the other room **heating** mode is set, priority will be given to the unit set to the heating mode. The first unit will go in standby and the Daikin eye will flash.

**INFORMATION**

- The cooling, drying, and fan only operation modes may be used at the same time.
- The automatic operation mode automatically selects cooling or heating, depending on the room temperature and the temperature setting. If the automatic operation mode is selected for all units, all units will operate in the mode of the first unit that was turned on.

Priority when using Outdoor unit quiet operation

Refer to "[5.9 Outdoor unit quiet operation](#)" [[▶ 42](#)].

- 1 Set Outdoor unit quiet operation in all rooms using the wireless remote controls of the units.
- 2 To cancel Outdoor unit quiet operation, you may stop operation in 1 room using a wireless remote control.
Result: Operation will stop in all rooms.  will remain on the display of the other wireless remote controls.
- 3 To remove the symbol from the other wireless remote controls, stop Outdoor unit quiet operation in all rooms separately.
Result: The  symbol will disappear.

When priority room setting is active

You can select a different operation mode for each room.

Example: Room A has priority, cooling operation mode is selected.

Operation mode in room B, C, D	Status of room B, C and D
Cooling, drying or fan only	Current operation mode maintained
Heating	Standby mode. Operation resumes when room A stops operating.
Automatic	If cooling operation continues. If heating units enter standby mode. Operation resumes when room A stops operating.

Priority when using Powerful operation

Example: Room A has priority. Rooms B, C and D are operating.

- 1 Set Powerful operation in room A.

Result: Capacity in room A is increased. Cooling or heating efficiency in rooms B, C and D may be slightly reduced.

Priority when using Outdoor unit quiet operation

Example: Room A has priority.

- 1 Set Outdoor unit quiet operation on one unit.

Result: All units enter the Outdoor unit quiet operation mode at once.

5.12.2 Night quiet mode

The Night quiet mode requires initial programming during installation. Please consult your dealer for assistance. This mode reduces the operation noise of the outdoor unit during the night by reducing the cooling efficiency.

The Night quiet mode is activated automatically when the temperature drops $\geq 5^{\circ}\text{C}$ below the highest temperature recorded that day.

5.12.3 Cooling/heating mode lock in Multi-system

The cooling/heating mode lock can be set via the Multi outdoor unit. Please consult your authorized dealer for assistance. The cooling/heating mode lock sets the unit forcibly to either cooling or heating operation. Activate this function if you wish to set all indoor units connected in a Multi-system to 1 operation mode.



INFORMATION

The Cooling/heating mode lock CANNOT be activated together with the priority room setting.

6 Energy saving and optimum operation



INFORMATION

- Even if the unit is turned OFF, it consumes electricity.
- When the power turns back on after a power break, the previously selected mode will be resumed.



CAUTION

NEVER expose little children, plants or animals directly to the airflow.



NOTICE

Do NOT place objects that should NOT get wet below the unit. Condensation on the unit or refrigerant pipes, or drain blockage may cause dripping. **Possible consequence:** Objects under the unit can get dirty or damaged.



WARNING

Do NOT place a flammable spray bottle near the air conditioner and do NOT use sprays near the unit. Doing so may result in a fire.



CAUTION

Do NOT operate the system when using a room fumigation-type insecticide. Chemicals could collect in the unit, and endanger the health of people who are hypersensitive to chemicals.

Observe the following precautions to ensure the system operates properly.

- Prevent direct sunlight from entering a room during cooling operation by using curtains or blinds.
- Make sure the area is well ventilated. Do NOT block any ventilation openings.
- Ventilate often. Extended use requires special attention to ventilation.
- Keep doors and windows closed. If the doors and windows remain open, air will flow out of your room causing a decrease in the cooling or heating effect.
- Be careful NOT to cool or heat too much. To save energy, keep the temperature setting at a moderate level.
- NEVER place objects near the air inlet or the air outlet of the unit. Doing so may cause a reduced heating/cooling effect or stop operation.
- Turn the breaker off when the unit is NOT used for longer periods of time. If the breaker is on, the unit consumes electricity. Before restarting the unit, turn the breaker on 6 hours before operation to ensure smooth running.
- Condensation may form if the humidity is above 80% or if the drain outlet gets blocked.
- Adjust the room temperature properly for a comfortable environment. Avoid excessive heating or cooling. Notice that it may take some time for the room temperature to reach the set temperature. Consider using the timer setting options.
- Adjust the air flow direction to avoid cool air from gathering on the floor or warm air against the ceiling. (Up during cooling or dry operation to the ceiling and down during heating operation.)
- Avoid direct air flow to room inhabitants.

- Operate the system within the recommended temperature range (26~28°C for cooling and 20~24°C for heating) to save energy.

7 Maintenance and service

In this chapter

7.1	Overview: Maintenance and service	53
7.2	To clean the indoor unit and wireless remote control	54
7.3	To clean the front panel	55
7.4	To open the front panel	55
7.5	About the air filters.....	56
7.6	To clean the air filters.....	56
7.7	To clean the titanium apatite deodorising filter and the silver particle filter (Ag-ion filter)	57
7.8	To replace the titanium apatite deodorising filter and the silver particle filter (Ag-ion filter).....	58
7.9	To close the front panel.....	58
7.10	To remove the front panel	59
7.11	To take following items into account before a long idle period.....	59

7.1 Overview: Maintenance and service

The installer has to perform a yearly maintenance.

Periodical inspections for refrigerant leaks may be required depending on the applicable legislation. Contact your installer for more information.

About the refrigerant

This product contains fluorinated greenhouse gases. Do NOT vent gases into the atmosphere.

Refrigerant type: R32

Global warming potential (GWP) value: 675



NOTICE

Applicable legislation on **fluorinated greenhouse gases** requires that the refrigerant charge of the unit is indicated both in weight and CO₂ equivalent.

Formula to calculate the quantity in CO₂ equivalent tonnes: GWP value of the refrigerant × total refrigerant charge [in kg]/1000

Contact your installer for more information.



NOTICE

Maintenance **MUST** be done by an authorised installer or service agent.

We recommend performing maintenance at least once a year. However, applicable legislation might require shorter maintenance intervals.



WARNING

- The refrigerant inside the unit is mildly flammable, but normally does NOT leak. If the refrigerant leaks in the room and comes in contact with fire from a burner, a heater, or a cooker, this may result in fire, or the formation of a harmful gas.
- Turn OFF any combustible heating devices, ventilate the room, and contact the dealer where you purchased the unit.
- Do NOT use the unit until a service person confirms that the part from which the refrigerant leaked has been repaired.



WARNING

- Do NOT pierce or burn refrigerant cycle parts.
- Do NOT use cleaning materials or means to accelerate the defrosting process other than those recommended by the manufacturer.
- Be aware that the refrigerant inside the system is odourless.



WARNING

The appliance shall be stored so as to prevent mechanical damage and in a well-ventilated room without continuously operating ignition sources (e.g. open flames, an operating gas appliance, or an operating electric heater). The room size shall be as specified in the General safety precaution.



DANGER: RISK OF ELECTROCUTION

To clean the air conditioner or air filter, be sure to stop operation and turn all power supplies OFF. Otherwise, an electrical shock and injury may result.



WARNING

To prevent electrical shocks or fire:

- Do NOT rinse the unit.
- Do NOT operate the unit with wet hands.
- Do NOT place any objects containing water on the unit.



CAUTION

After a long use, check the unit stand and fitting for damage. If damaged, the unit may fall and result in injury.



CAUTION

Do NOT touch the heat exchanger fins. These fins are sharp and could result in cutting injuries.



WARNING

Be careful with ladders when working in high places.

7.2 To clean the indoor unit and wireless remote control



WARNING

Improper detergents or cleaning procedure may cause damage on plastic components or water leakage. Splashed detergent on electric components, such as motors, may cause failure, smoke or ignition.



DANGER: RISK OF ELECTROCUTION

Before cleaning, be sure to stop the operation, turn the breaker OFF or pull out the supply cord. Otherwise, an electrical shock and injury may result.

**NOTICE**

- Do NOT use gasoline, benzene, thinner, polishing powder or liquid insecticide. **Possible consequence:** Discoloration and deformation.
- Do NOT use water or air of 40°C or higher. **Possible consequence:** Discoloration and deformation.
- Do NOT use polishing compounds.
- Do NOT use a scrubbing brush. **Possible consequence:** The surface finishing peels off.
- As an end user, you may NEVER clean inside parts of the unit by yourself; this work must be performed by a qualified service person. Contact your dealer.

- 1 Clean with a soft cloth. If it is difficult to remove stains, use water or a neutral detergent.

7.3 To clean the front panel

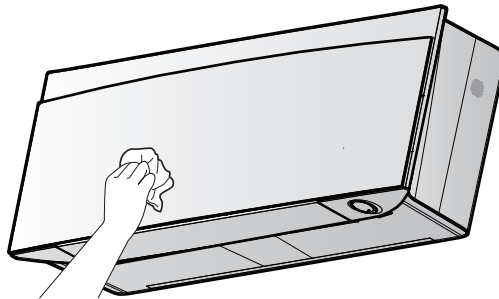

- 1 Clean the front panel with a soft cloth. If it is difficult to remove stains, use water or a neutral detergent.

7.4 To open the front panel

- 1 Stop operation by .

Result: The front panel closes automatically.

- 2 Open the front panel using the wireless remote control. See "[4.4.2 Open the front panel](#)" [▶ 22].

Result: The front panel opens.

- 3 Turn the power supply OFF.
- 4 Pull down both locks on the back of the front panel.
- 5 Open the front panel until the support fits into the fixing tab.

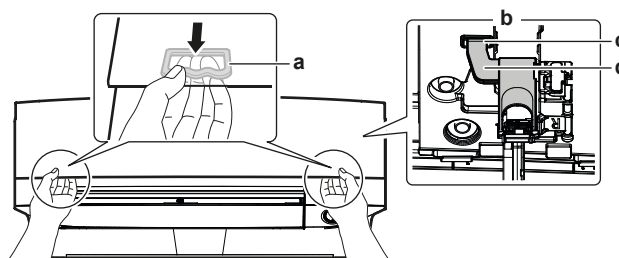

- a Lock (1 on each side)
- b Backside of the front panel
- c Fixing tab
- d Support

**INFORMATION**

If you CANNOT find the wireless remote control or you use another optional controller. Pull the front panel carefully up by hand as shown in the following figure.

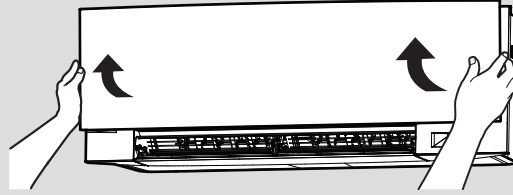

7.5 About the air filters

Operating the unit with dirty filters means that the filter:

- CANNOT deodorise the air,
- CANNOT clean the air,
- poor heating/cooling,
- causes odour.

7.6 To clean the air filters

- 1 Push the tab at the centre of each air filter, then pull it down.
- 2 Pull out the air filters.

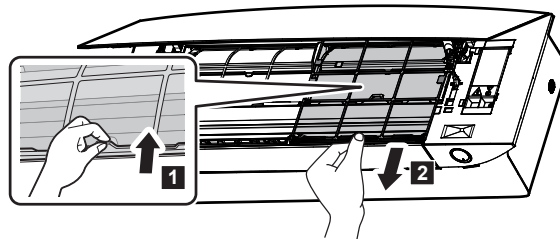

- 3 Remove the titanium apatite deodorising filter and silver particle filter from the tabs.

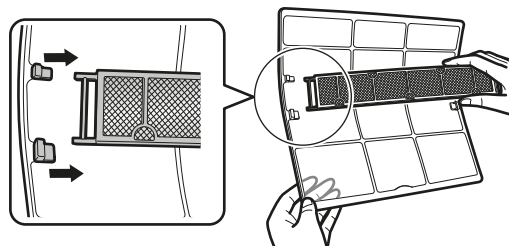

- 4 Wash the air filters with water or clean them with a vacuum cleaner.

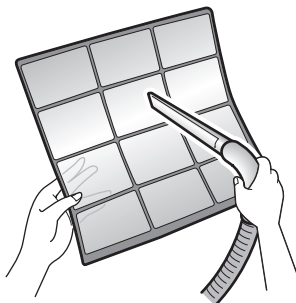

- 5 Soak in lukewarm water for about 10 to 15 minutes.

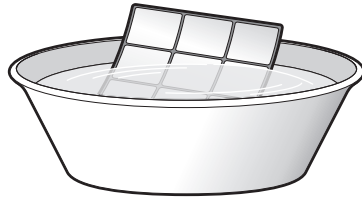
**INFORMATION**

- If the dust does NOT come off easily, wash the air filters with a neutral detergent diluted in lukewarm water. Dry the air filters in the shade.
- Be sure to remove the titanium apatite deodorising and silver particle filters.
- It is recommended to clean the air filters every 2 weeks.

7.7 To clean the titanium apatite deodorising filter and the silver particle filter (Ag-ion filter)

**INFORMATION**

Clean the filter with water every 6 months.

- 1 Remove titanium apatite deodorising filter and the silver allergen removal air purifying filter from all 4 claws.

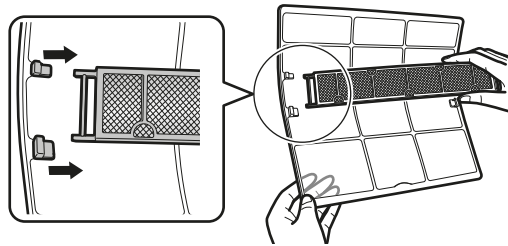

a Claw

- 2 Remove the dust from the filter with a vacuum cleaner.

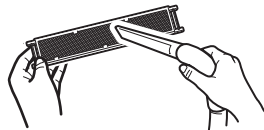

- 3 Soak the filter for 10 to 15 minutes in warm water.

Note: Do NOT remove the filter from the frame.



- 4 After washing, shake off remaining water and dry the filter in the shade. Do NOT wring out the filter when removing water.

7.8 To replace the titanium apatite deodorising filter and the silver particle filter (Ag-ion filter)



INFORMATION

Replace the filter every 3 years.

- 1 Remove the filter from the tabs of the filter frame and replace the filter with a new one.

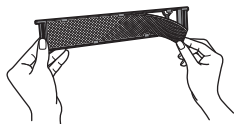

INFORMATION

- Do NOT throw away the filter frame, but use it again.
- Dispose of the old filter as non-flammable waste.

To order titanium apatite deodorising filter or silver particle filters, contact your dealer.

Item	Part number
Titanium deodorising filter	KAF970A46
Silver particle filter	KAF057A41

7.9 To close the front panel

- 1 Set the filters as they were.
- 2 Lift the front panel slightly and remove the support from the fixing tab.

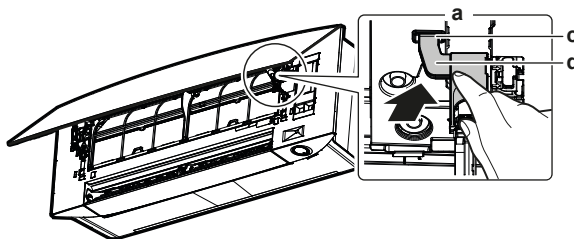

- a Backside of the front panel
- b Fixing tab
- c Support

- 3 Close the front panel.

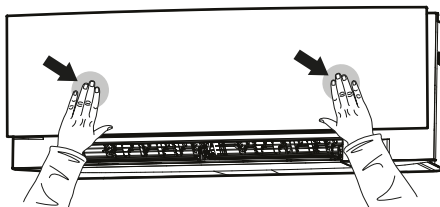

- 4 Gently press the front panel down until it clicks.

7.10 To remove the front panel



INFORMATION

Remove the front panel only in case it **MUST** be replaced.

- 1 Open the front panel. See "[7.4 To open the front panel](#)" [▶ 55].
- 2 Open the panel locks on the back side of the panel (1 on each side).

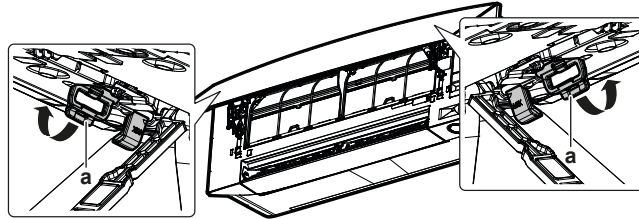

a Panel lock

- 3 Push the right arm lightly to the right to disconnect the shaft from the shaft slot on the right side.

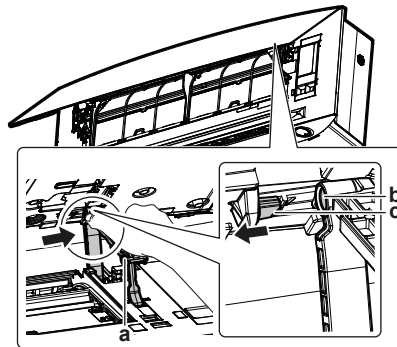

a Arm
b Shaft slot
c Shaft

- 4 Disconnect the front panel shaft from the shaft slot on the left side.

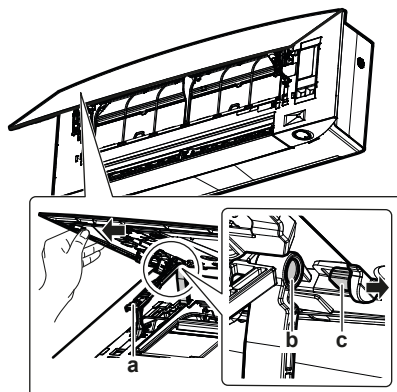

a Arm
b Shaft slot
c Shaft

- 5 Remove the front panel.
- 6 To re-install the front panel, perform the steps in the opposite order.

7.11 To take following items into account before a long idle period

Operate the unit several hours in **fan only** mode to dry the inside of the unit.

- 1 Set the mode to fan only, see "[5.3 Operation mode and temperature setpoint](#)" [[▶ 33](#)].
- 2 After operation stops, turn the breaker OFF.
- 3 Clean the air filters and replace them in their original positions.
- 4 Remove the batteries from the wireless remote control.



INFORMATION

It is recommended to have periodical maintenance performed by a specialist. For specialist maintenance, contact your dealer. Maintenance costs shall be borne by the customer.

In certain operating conditions the inside of the unit may get dirty after several seasons of use. This results in poor performance.

8 Troubleshooting

If one of the following malfunctions occurs, take the measures shown below and contact your dealer.



WARNING

Stop operation and shut OFF the power if anything unusual occurs (burning smells etc.).

Leaving the unit running under such circumstances may cause breakage, electrical shock or fire. Contact your dealer.

The system **MUST** be repaired by a qualified service person.

Malfunction	Measure
If a safety device such as a fuse, a breaker or an earth leakage breaker frequently actuates or the ON/OFF switch does NOT function properly.	Turn OFF the main power switch.
If water leaks from the unit.	Stop operation.
The operation switch does NOT function properly.	Turn OFF the power supply.
The Daikin eye flashes and you can check the error code by the wireless remote control. To display the error code, see "8.2 Solving problems based on error codes" [▶ 64] .	Notify your installer and report the error code.

If the system does NOT operate properly except for the above mentioned cases and none of the above mentioned malfunctions is evident, investigate the system in accordance with the following procedures.

Malfunction	Measure
If the system does NOT operate at all.	<ul style="list-style-type: none"> ▪ Check if there is no power failure. Wait until power is restored. If a power failure occurs during operation, the system automatically restarts immediately after power is restored. ▪ Check if the front panel is opened during operation. Stop operation and restart the indoor unit using the wireless remote control or other user interface (if connected). ▪ Check if no fuse has blown or breaker is activated. Change the fuse or reset the breaker if necessary. ▪ Check the batteries of the wireless remote control. ▪ Check the timer setting.
The system suddenly stops operating.	<ul style="list-style-type: none"> ▪ Check if the air inlet or outlet of the outdoor or indoor unit is NOT blocked by obstacles. Remove any obstacles and make sure the air can flow freely. ▪ The air conditioner may stop operating after sudden large voltage fluctuations to protect the system. It automatically resumes operation after about 3 minutes.

Malfunction	Measure
The fan will stop during airflow operation.	If the set temperature is reached, the airflow rate is reduced and operation stops. Operation will resume automatically when the indoor temperature rises or falls.
The flaps do NOT start to swing immediately.	The indoor unit is adjusting the position of the flaps. The flaps will start moving soon.
Operation does NOT start soon.	In case the ON/OFF button was pressed right after operation was stopped or if the mode was changed. Operation will start after 3 minutes to protect the system.
The system operates, but cooling or heating is insufficient.	<ul style="list-style-type: none"> ▪ Check the airflow rate setting. Refer to "5.4 Airflow rate" [▶ 34]. ▪ Check the temperature setting. Refer to "5.3.1 To start/stop operation mode and to set the temperature" [▶ 34]. ▪ Check if the airflow direction setting is appropriate. Refer to "5.5 Airflow direction" [▶ 35]. ▪ Check if the air inlet or outlet of the outdoor or indoor unit is NOT blocked by obstacles. Remove any obstacles and make sure the air can flow freely. ▪ Check if the air filters are clogged. Clean the air filters. Refer to "7 Maintenance and service" [▶ 53]. ▪ Check for open doors or windows. Close doors and windows to prevent wind from coming in. ▪ Check if the unit operates in Econo or Outdoor unit quiet operation. Refer to "5.8 Econo operation" [▶ 41] and "5.9 Outdoor unit quiet operation" [▶ 42]. ▪ Check if there is any furniture directly under or next to the indoor unit. Move the furniture.
The system operates, but heating is insufficient (air is NOT blown from the unit).	<ul style="list-style-type: none"> ▪ The air conditioner may be warming up for heating operation. Wait for 1 to 4 minutes. ▪ If a flowing sound is heard, the outdoor unit may be in defrost operation. Wait for 4 to 12 minutes.
The front panel does NOT open.	Check for obstacles and try to open the front panel using the wireless remote control. Refer to "7.4 To open the front panel" [▶ 55].
The ON/OFF timer does NOT operate according to the settings.	<ul style="list-style-type: none"> ▪ Check if the Weekly timer and ON/OFF timer are set to the same time. Change or deactivate the setting. Refer to "5.11.2 OFF/ON timer operation" [▶ 45] and "5.11.3 Weekly timer operation" [▶ 47]. ▪ Check if the clock and the day of the week are set correctly. Refer to "5.11.1 The clock setting" [▶ 43].

Malfunction	Measure
An abnormal function happens during operation.	The air conditioner may malfunction because of lightning or radio waves. Turn the breaker OFF and back ON.
The unit does NOT receive signals from the wireless remote control.	<ul style="list-style-type: none"> Check the batteries of the wireless remote control. Refer to "4.1 To insert the batteries" [▶ 20]. Make sure that the transmitter is NOT exposed to direct sunlight. Check if there are any electronic starter type fluorescent lamps in the room. Contact your dealer.
The user interface display is blank.	Replace the batteries of the user interface. Refer to "4.1 To insert the batteries" [▶ 20].
Other electric appliances start to operate.	If the user interface signals operate other electric appliances, move the other appliances away, and contact your dealer.

After checking all the items above, if it is impossible to fix the problem yourself, contact your installer and state the symptoms, the complete model name of the unit (with manufacturing number if possible) and the installation date.

8.1 Troubleshooting for wireless LAN connection

The following table provides a brief description of how to deal with some problems. If none of the following solutions fix the problem, go to app.daikineurope.com for more information and FAQ.

Problem	Measure
Connection to the wireless LAN is not possible (Daikin eye is NOT blinking during wireless LAN connection setting).	<ul style="list-style-type: none"> Try operating the unit with the wireless remote controller or other user interface. Check if the power is on. Turn the unit off and back on again.
The wireless LAN is NOT visible on the unit overview screen (Home screen) after configuration of the WLAN adapter (WPS option).	<ul style="list-style-type: none"> Make sure the wireless LAN is close enough to the communication device. Check if communication is OK. Make sure that the smart device is connected to the same wireless network as the wireless LAN. Try resetting to the factory default and repeat the setting. See "To reset the connection setting to the factory default" [▶ 26].

Problem	Measure
The wireless LAN is NOT visible in the available Wi-Fi networks list on the smart device (Access point option).	<ul style="list-style-type: none"> Try switching between access point and WPS setting to change the wireless channel. The wireless channel MUST be between 1~13. Check if communication is OK. Try resetting to the factory default and repeat the setting. See "To reset the connection setting to the factory default" [▶ 26].
The indoor/outdoor temperature value displayed in the ONECTA app differs from the value measured by other appliances.	<ul style="list-style-type: none"> The ONECTA app displays the indoor/outdoor temperature for the area surrounding the indoor/outdoor unit only. The measured temperature for other appliances may differ due to different conditions around the unit (e.g. direct sunlight, frost accumulation...) The temperature displayed in the ONECTA app is for information only.

8.2 Solving problems based on error codes

Fault diagnosis by the wireless remote control

If the unit runs into a problem, you can identify the fault by checking the error code by the wireless remote control. It is important to understand the problem and take measures before resetting the error code. This should be done by a licensed installer or your local dealer.

To check the error code by the wireless remote control

- Press to enter the main menu and navigate to the wireless remote control settings menu using and .

Wireless remote control setting menu Software version (self-diagnosis menu)

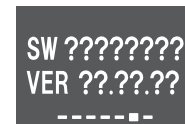



- Press to enter the menu.
- Navigate to the software and version screen using and .
- Keep pressed for at least 5 seconds to enter the self-diagnosis menu.
- Navigate to the error code indication screen using and . Press to confirm your selection.

Error code indication





Error code list



- 6 Aim the wireless remote control at the unit and scroll through the list of error codes using  and , until you hear a long beep.

Result: A long beep indicates the corresponding error code.

- 7 Press  to return to the home screen or press  to return to the self-diagnosis menu.

8.3 Symptoms that are NOT system malfunctions

The following symptoms are NOT system malfunctions:

8.3.1 Symptom: A sound like water flowing is heard

- This sound is caused by the refrigerant flowing in the unit.
- This sound may be generated when water is flowing away from the unit during cooling or drying operation.

8.3.2 Symptom: A blowing sound is heard

This sound is generated when the direction of the refrigerant flow is changed (e.g. when switching from cooling to heating).

8.3.3 Symptom: A ticking sound is heard

This sound is generated when the unit slightly expands or contracts with changes in temperature.

8.3.4 Symptom: A whistling sound is heard

This sound is generated by the refrigerant flowing during defrost operation.

8.3.5 Symptom: A clicking sound during operation or idle time is heard

This sound is generated when the refrigerant control valves or electrical parts operate.

8.3.6 Symptom: A clapping sound is heard

This sound is generated when an external device sucks air out of the room (e.g. exhaust fan, extractor hood) while the doors and windows in the room are closed. Open the doors or windows, or turn off the device.

8.3.7 Symptom: A faxing sound is heard when the front panel is fully open

After power failure, the front panel opens automatically. If the front panel was already fully open before power failure, an opening mechanism emits faxing sound.

8.3.8 Symptom: White mist comes out of a unit (Indoor unit, outdoor unit)

When the system is changed over to heating operation after defrost operation. Moisture generated by defrost becomes steam and is exhausted.

8.3.9 Symptom: The units can give off odours

The unit can absorb the smell of rooms, furniture, cigarettes, etc., and then emit it again.

8.3.10 Symptom: The outdoor fan rotates while the air conditioner is not in operation

- **After operation has stopped.** The outdoor fan continues to rotate for another 30 seconds for system protection.
- **While the air conditioner is not in operation.** When the outdoor temperature is very high, the outdoor fan starts to rotate for system protection.

8.3.11 Symptom: Airflow rate setting does NOT resume when Comfort airflow is deactivated by ONECTA app

If Comfort airflow operation is deactivated by ONECTA app, the airflow rate does NOT return to previous airflow rate setting, and indoor unit operates in automatic airflow rate.

8.3.12 Symptom: The vertical automatic swing operation does NOT resume after the Comfort airflow operation is deactivated

Even if the Vertical automatic swing was active before Comfort airflow operation was deactivated the Vertical automatic swing will NOT resume.

8.3.13 Symptom: Some operation icons are not visible on the wireless remote control, or some functions cannot be activated in the ONECTA app

Some combinations of features are not permitted (example: Fan only mode and Outdoor unit quiet operation). This features may display at the ONECTA app, but function CANNOT be activated.

8.3.14 Symptom: In ONECTA app, powerful operation is NOT indicated as active

When the powerful operation is activated while indoor unit is OFF, the powerful operation may not be displayed as active for 2 minutes until the cloud data are updated.

9 Disposal

**NOTICE**

Do NOT try to dismantle the system yourself: dismantling of the system, treatment of the refrigerant, oil and other parts **MUST** comply with applicable legislation. Units **MUST** be treated at a specialised treatment facility for reuse, recycling and recovery.

10 Glossary

Dealer

Sales distributor for the product.

Authorised installer

Technical skilled person who is qualified to install the product.

User

Person who is owner of the product and/or operates the product.

Applicable legislation

All international, European, national and local directives, laws, regulations and/or codes that are relevant and applicable for a certain product or domain.

Service company

Qualified company which can perform or coordinate the required service to the product.

Installation manual

Instruction manual specified for a certain product or application, explaining how to install, configure and maintain it.

Operation manual

Instruction manual specified for a certain product or application, explaining how to operate it.

Accessories

Labels, manuals, information sheets and equipment that are delivered with the product and that need to be installed according to the instructions in the accompanying documentation.

Optional equipment

Equipment made or approved by Daikin that can be combined with the product according to the instructions in the accompanying documentation.

Field supply

Equipment NOT made by Daikin that can be combined with the product according to the instructions in the accompanying documentation.







ERC

DAIKIN INDUSTRIES CZECH REPUBLIC s.r.o.
U Nové Hospody 1155/1, 301 00 Plzeň Skvrňany, Czech Republic

DAIKIN EUROPE N.V.
Zandvoordestraat 300, B-8400 Oostende, Belgium

Copyright 2024 Daikin

4P518786-20Q 2024.07